

# TKHD series

Heavy duty cable carriers  
for long travel lengths and  
high additional loads

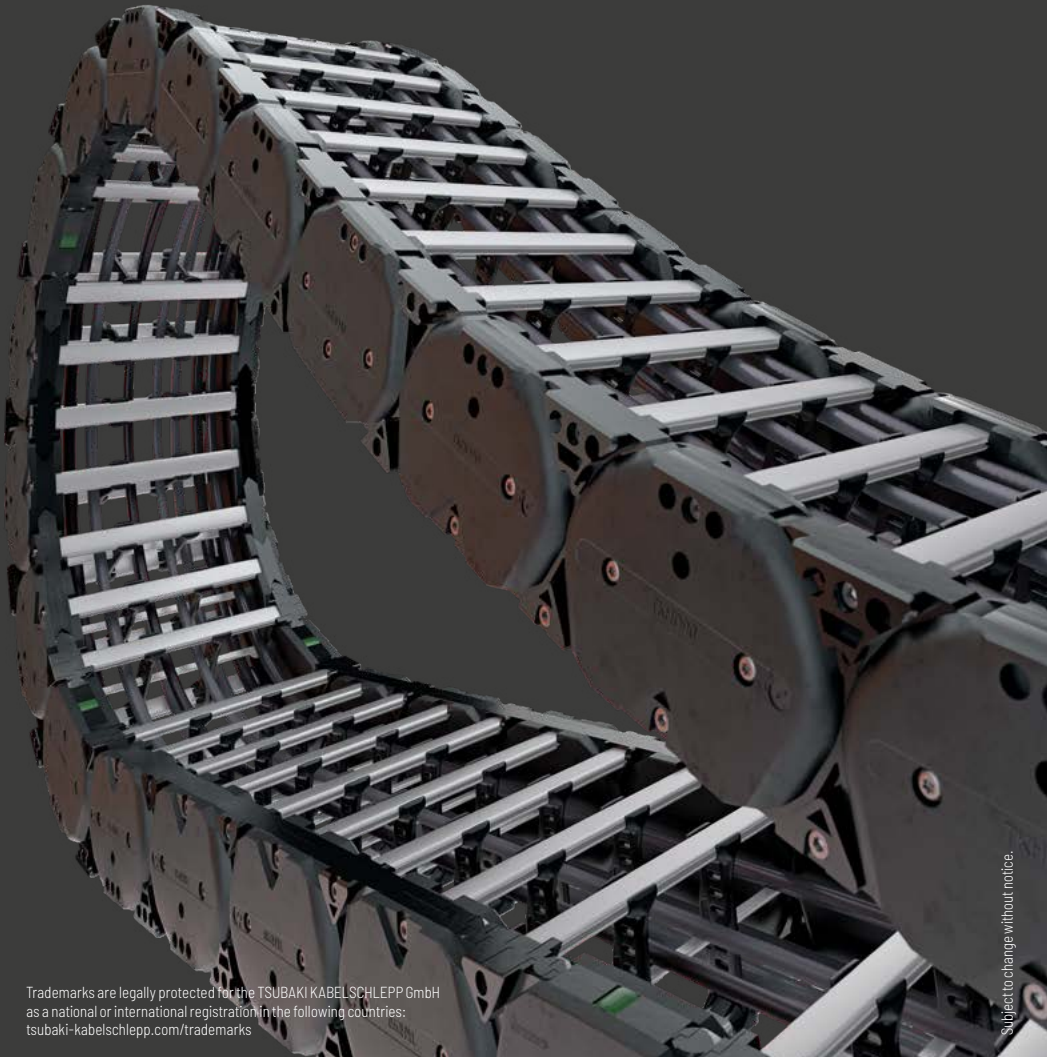

Trademarks are legally protected for the TSUBAKI KABELSCHLEPP GmbH as a national or international registration in the following countries:

[tsubaki-kabelschlepp.com/trademarks](https://tsubaki-kabelschlepp.com/trademarks)

Subject to change without notice.

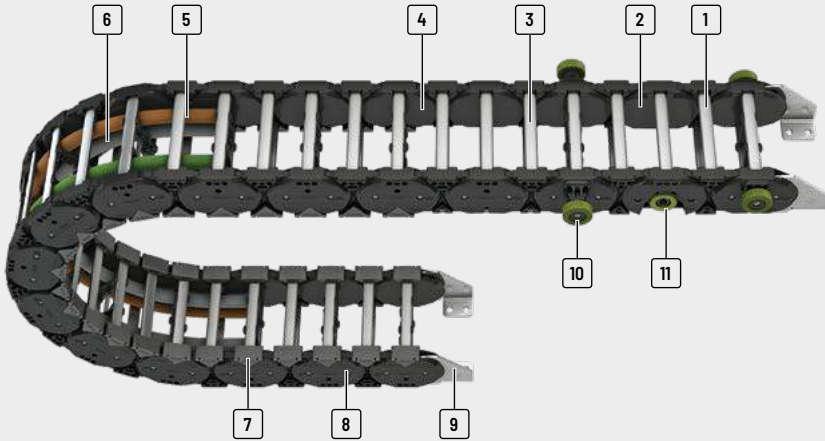

- |   |  |  |  |
|---|--|--|--|
| <p><b>1</b> Aluminum stays available in <b>1 mm width sections</b></p> <p><b>2</b> Plastic chain link plates</p> <p><b>3</b> Quick and easy opening to the inside or outside for cable laying</p> | <p><b>4</b> Cable-friendly interior – no interfering edges</p> <p><b>5</b> Fixable dividers</p> <p><b>6</b> Dividers and subdivision for separating the cables</p> | <p><b>7</b> Replaceable glide shoes for increased service life in gliding application</p> <p><b>8</b> Robust, multiple stop system</p> <p><b>9</b> Steel installation brackets</p> | <p><b>10</b> RSC-system with external roll</p> <p><b>11</b> With integrated roll for standard guide channels</p> |
|---|--|--|--|

## Features

- |  |   |
|--|---|
| <ul style="list-style-type: none"> <li>» Massive, enclosed, stain-repellent stop system</li> <li>» Massive sidebands through robust double fork-bracket-construction</li> <li>» Sidebands easy to assemble</li> <li>» Reinforced pin bore connection</li> <li>» Integrated noise damping</li> <li>» Quick and easy opening to the inside or outside for cable laying</li> <li>» Soil-resistant outer contour</li> <li>» Easy change of components</li> </ul> | <ul style="list-style-type: none"> <li>» Maintenance-free</li> <li>» Symmetrical force curve in the sideband</li> <li>» Quiet and low-wear operating through polygon-optimized contour and radii</li> <li>» Reduce drive power through less friction</li> </ul> |
|--|---|

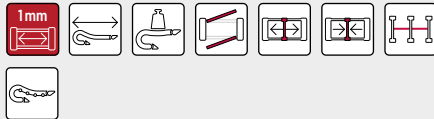

**Variable vertical and horizontal inner distribution optional with fixable dividers**



**Suitable also for roller-mounted application (RSC)**



**Replaceable glide shoes for longer service life in gliding applications**



**Roller chain for travel distances up to 1200 m**

PROTUM®  
series

K  
series

UNIFLEX  
Advanced  
series

M  
series

TK-ID  
series

XL  
series

QUANTUM®  
series

TKR  
series

TKA  
series

UAT  
series

Type	Opening variant	Stay variant	$h_i$ [mm]	$h_G$ [mm]	$B_i$ [mm]	$B_k$ [mm]	$B_i$ - grid [mm]	t [mm]	KR [mm]	Additional load $\leq$ [kg/m]	Cable- $d_{max}$ [mm]
PROTUM <sup>®</sup> series											
K series											
<b>TKHD85</b>											
		RMF	58	84	100 - 800	154 - 854	1	85	240 - 400	50	46
UNIFLEX Advanced series											
<b>TKHD90</b>											
		RMF	87	117	100 - 800	170 - 870	1	90	250 - 500	100	69
M series											
<b>TKHD85-R</b>											
		RMF	58	84,5	100 - 800	154 - 854	1	85	240 - 400	50	46
XL series											
<b>TKHD90-R</b>											
		RMF	87	117,5	100 - 800	170 - 870	1	90	250 - 500	100	69
QUANTUM <sup>®</sup> series											
TKR series											
TKA series											
UAT series											

Unsupported arrangement			Gliding/Rolling arrangement			Inner Distribution				Movement			Page
Travel length ≤ [m]	$v_{max} \leq [m/s]$	$a_{max} \leq [m/s^2]$	Travel length ≤ [m]	$v_{max} \leq [m/s]$	$a_{max} \leq [m/s^2]$	TS0	TS1	TS2	TS3	vertical hanging or standing	lying on the side	rotating arrangement	
-	5	20	200	5	2,5	•	•	-	-	•	-	-	460
13,5	8	20	200	5	2,5	•	•	-	-	•	-	-	466
-	-	-	1200	5	50	•	•	-	-	•	-	-	472
-	-	-	1500	10	50	•	•	-	-	-	-	-	478

PROTUM® series

K series

UNIFLEX Advanced series

M series

TKHD series

XL series

QUANTUM® series

TKR series

TKA series

UAT series

# TKHD85



**Pitch**  
85 mm



**Inner height**  
58 mm



**Inner widths**  
100 – 800 mm



**Bending radii**  
240 – 400 mm

## Stay variants



**Aluminum stay RMF** ..... page 460

### Frame stay, solid

- » Aluminum profile bars for heavy loads and large cable carrier widths. Easy threaded connection.
- » **Inside/outside:** Threaded joint easy to release.

PROTUM®  
series

K  
series

UNIFLEX  
Advanced  
series

M  
series

TKHD  
series

XL  
series

QUANTUM®  
series

TKR  
series

TKA  
series

UAT  
series



### TOTALTRAX® complete systems

Benefit from the advantages of the TOTALTRAX® complete system. A complete delivery from one source – with a warranty certificate on request! Learn more at [tsubaki-kabelschlepp.com/totaltrax](http://tsubaki-kabelschlepp.com/totaltrax)

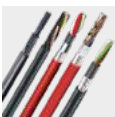

### TRAXLINE® cables for cable carriers

Hi-flex electric cables which were specially developed, optimised and tested for use in cable carriers can be found at [tsubaki-kabelschlepp.com/traxline](http://tsubaki-kabelschlepp.com/traxline).

## Unsupported arrangement

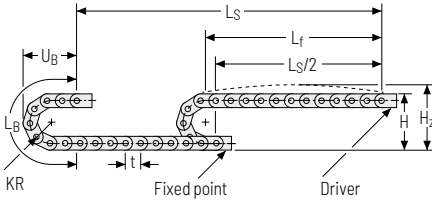

KR [mm]	H [mm]	H <sub>z</sub> [mm]	L <sub>B</sub> [mm]	U <sub>B</sub> [mm]
240	574	704	930	300
300	694	824	1120	360
350	794	924	1270	410
400	894	1024	1430	460



**Speed**  
up to 5 m/s



**Acceleration**  
up to 20 m/s<sup>2</sup>



**Additional load**  
up to 50 kg/m

PROTUM®  
series

K  
series

UNIFLEX  
Advanced  
series

M  
series

TKHD  
series

XL  
series

## Gliding arrangement | GO module with chain links optimized for gliding

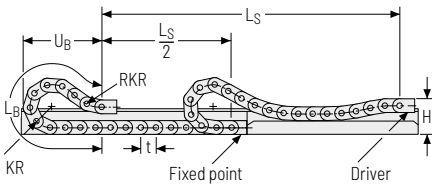

KR [mm]	H [mm]	GO module RKR [mm]	L <sub>B</sub> [mm]	U <sub>B</sub> [mm]	Q <sub>z max</sub> [kg/m]
240	252	375	2410	1050	60
300	252	375	2920	1270	60
350	252	375	3380	1450	40
400	252	375	3855	1630	20



**Speed**  
up to 5 m/s



**Acceleration**  
up to 2.5 m/s<sup>2</sup>



**Travel length**  
up to 200 m



**Additional load**  
up to 50 kg/m



The gliding cable carrier must be guided in a channel.  
See p. 850.

The GO module mounted on the driver is a defined sequence of 6 adapted KR/RKR link plates.

Glide shoes must be used for gliding applications.

QUANTUM®  
series

TKR  
series

TKA  
series

UAT  
series



Our technical support can provide help for gliding arrangements:  
[technik@kabelschlepp.de](mailto:technik@kabelschlepp.de)

## Aluminum stay RMF – frame stay solid

- » Aluminum profile bars for heavy loads and large cable carrier widths.
- » Available customized in **1 mm grid**.
- » **Inside/outside:** Threaded joint easy to release.



Stay arrangement on each chain link (**VS: fully-stayed**)



**1 mm** B<sub>i</sub> 100 – 800 mm  
in 1 mm width sections

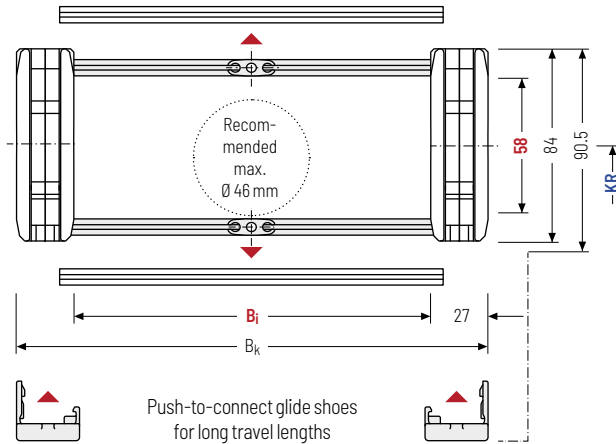

The maximum cable diameter strongly depends on the bending radius and the desired cable type. Please contact us.

### Calculating the cable carrier length

**Cable carrier length  $L_k$**

$$L_k \approx \frac{L_S}{2} + L_B$$

Cable carrier length  $L_k$  rounded to pitch  $t$  for odd number of chain links

$h_i$ [mm]	$h_g$ [mm]	$h_{g'}$ [mm]	$B_i$ [mm]*	$B_k$ [mm]	$KR$ [mm]				$q_k$ [kg/m]
58	84	90.5	100 – 800	$B_i + 54$	240	300	350	400	6.021 – 13.119

\* in 1 mm width sections

### Order example



**TKHD85**

Type

**400**

$B_i$  [mm]

**RMF**

Stay variant

**300**

$KR$  [mm]

**2125**

$L_k$  [mm]

**VS**

Stay arrangement

### Divider systems

As a standard, the divider system is mounted on every 4<sup>th</sup> chain link on the inside plate.

As a standard, dividers and the complete divider system (dividers with height separations) can be moved in the cross section (**version A**).

For applications with lateral acceleration and free hanging on the side, the dividers can be attached by simple insertion of a fixing profile into the RMF stay, available as an accessory (**version B**).

### Divider system TSO without height separation

Vers.	$a_T$ min [mm]	$a_x$ min [mm]	$a_c$ min [mm]	$a_x$ grid [mm]	$n_T$ min
A	10/13*	20	16	-	-
B	10/13*	20	16	5	-

\* With glide shoes

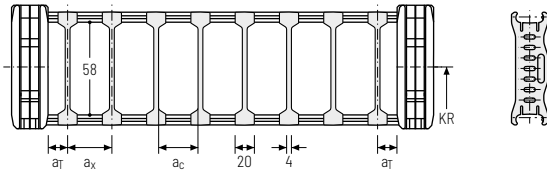

The dividers can be moved within the cross section (version A) or fixed (version B).

### Divider system TS1 with continuous height separation

Vers.	$a_T$ min [mm]	$a_x$ min [mm]	$a_c$ min [mm]	$a_x$ grid [mm]	$n_T$ min
A	10/13*	20	16	-	2
B	10/13*	20	16	5	2

\* With glide shoes

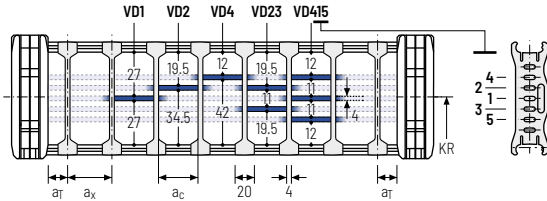

The dividers can be moved within the cross section (version A) or fixed (version B).

### Order example

TS1

·

A

·

3

-

VD1

:

VD3

Divider system
Version
 $n_T$ 
Height separation

Please state the designation of the divider system (**TS0, TS1,...**), the version, and the number of dividers per cross section [ $n_T$ ].

When using divider systems with height separation (**TS1**), please additionally state the position (e.g. VD1) viewed from the left driver belt. You are welcome to add a sketch to your order.

PROTUM® series
K series
UNIFLEX Advanced series
M series
TKHD series
XL series
QUANTUM® series
TKR series
TKA series
UAT series



## End connectors - steel short

The connection variants on the fixed point and on the driver can be combined and changed later on, if necessary.

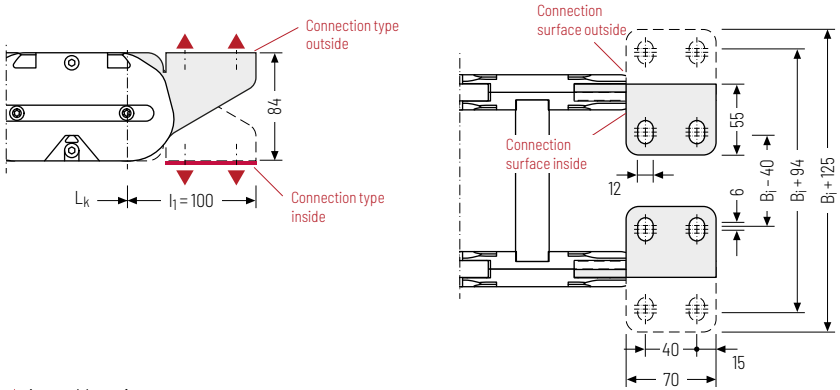

▲ Assembly options

### Connection point

- F - fixed point
- M - driver

### Connecting surface

- A - connecting surface outside
- I - connecting surface inside

### Connection type

- A - threaded joint outside (standard)
- I - threaded joint inside

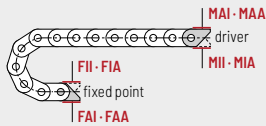

## Order example



Steel	F	A	I
Steel	M	A	I
End connector	Connection point	Connection type	Connecting surface



We recommend the use of strain reliefs at the driver and fixed point. See from p. 908.

## End connectors LF - steel long

The connection variants on the fixed point and on the driver can be combined and changed later on, if necessary.

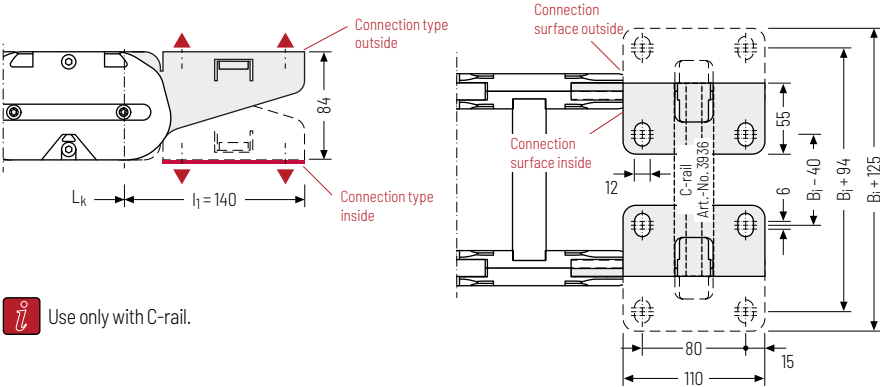

Use only with C-rail.

Assembly options

- |                         |                                |                                       |
|-------------------------|--------------------------------|---------------------------------------|
| <b>Connection point</b> | <b>Connecting surface</b>      | <b>Connection type</b>                |
| F - fixed point         | A - connecting surface outside | A - threaded joint outside (standard) |
| M - driver              | I - connecting surface inside  | I - threaded joint inside             |

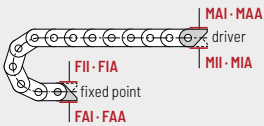

### Order example

	Steel	F	A	I
	Steel	M	A	I
	End connector	Connection point	Connection type	Connecting surface

### Additional product information online



Installation instructions, etc.:  
Additional info via your smartphone or check online at [tsubaki-kabelschlepp.com/downloads](http://tsubaki-kabelschlepp.com/downloads)



Configure your cable carrier here:  
[online-engineer.de](http://online-engineer.de)

PROTUM® series
K series
UNIFLEX Advanced series
M series
<b>TKHD series</b>
XL series
QUANTUM® series
TKR series
TKA series
UAT series

# TKHD90



**Pitch**  
90 mm



**Inner height**  
87 mm



**Inner widths**  
100 – 800 mm



**Bending radii**  
250 – 500 mm

## Stay variants



**Aluminum stay RMF** ..... page 466

### Frame stay, solid

- » Aluminum profile bars for heavy loads and large cable carrier widths. Easy threaded connection.
- » **Inside/outside:** Threaded joint easy to release.

PROTUM®  
series

K  
series

UNIFLEX  
Advanced  
series

M  
series

TKHD  
series

XL  
series

QUANTUM®  
series

TKR  
series

TKA  
series

UAT  
series



### TOTALTRAX® complete systems

Benefit from the advantages of the TOTALTRAX® complete system. A complete delivery from one source – with a warranty certificate on request! Learn more at [tsubaki-kabelschlepp.com/totaltrax](http://tsubaki-kabelschlepp.com/totaltrax)

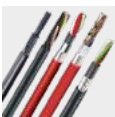

### TRAXLINE® cables for cable carriers

Hi-flex electric cables which were specially developed, optimised and tested for use in cable carriers can be found at [tsubaki-kabelschlepp.com/traxline](http://tsubaki-kabelschlepp.com/traxline).

Unsupported arrangement

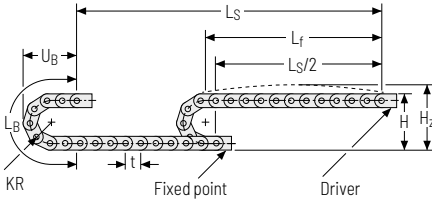





KR [mm]	H [mm]	H <sub>2</sub> [mm]	L <sub>B</sub> [mm]	U <sub>B</sub> [mm]
250	675,5	860	965	510
310	795,5	980	1154	570
360	895,5	1080	1311	620
500	1175,5	1360	1751	680

Load diagram for unsupported length depending on the additional load.

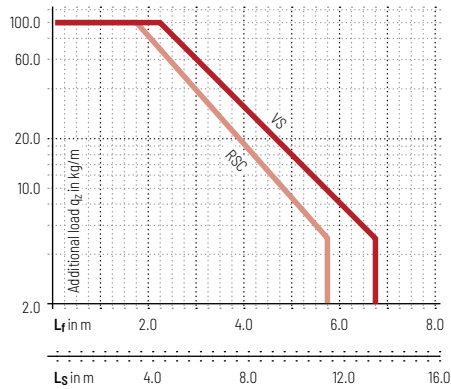
Sagging of the cable carrier is technically permitted for extended travel lengths, depending on the specific application.

Intrinsic cable carrier weight  $q_k = 10 \text{ kg/m}$ . For other inner widths, the maximum additional load changes.





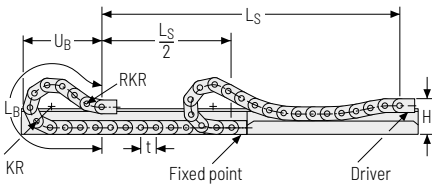

-  **Speed**  
up to 8 m/s
-  **Acceleration**  
up to 20 m/s<sup>2</sup>
-  **Travel length**  
up to 13.5 m
-  **Additional load**  
up to 100 kg/m

Gliding arrangement | GO module with chain links optimized for gliding



KR [mm]	H [mm]	GO module RKR [mm]	L <sub>B</sub> [mm]	U <sub>B</sub> [mm]	q <sub>z max</sub> [kg/m]
250	351	600	2420	1090	100
310	351	600	2780	1208	100
360	351	600	3230	1380	90
500	351	600	4400	1820	75

-  **Speed**  
up to 5 m/s
-  **Acceleration**  
up to 2.5 m/s<sup>2</sup>
-  **Travel length**  
up to 200 m
-  **Additional load**  
up to 100 kg/m

 The gliding cable carrier must be guided in a channel. See p. 850.

The GO module mounted on the driver is a defined sequence of 6 adapted KR/RKR link plates.

Glide shoes must be used for gliding applications.

 Our technical support can provide help for gliding arrangements: [technik@kabelschlepp.de](mailto:technik@kabelschlepp.de)

## Aluminum stay RMF – frame stay solid

- » Aluminum profile bars for heavy loads and large cable carrier widths.
- » Available customized in **1 mm grid**.
- » **Inside/outside:** Threaded joint easy to release.



Stay arrangement on each chain link (**VS: fully-stayed**)



**1 mm** B<sub>i</sub> 100 – 800 mm  
in 1 mm width sections

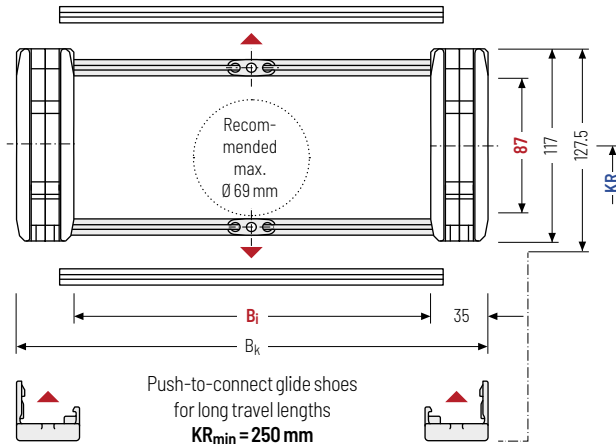

The maximum cable diameter strongly depends on the bending radius and the desired cable type. Please contact us.

### Calculating the cable carrier length

#### Cable carrier length L<sub>k</sub>

$$L_k \approx \frac{L_S}{2} + L_B$$

Cable carrier length L<sub>k</sub> rounded to pitch t for odd number of chain links

h <sub>i</sub> [mm]	h <sub>g</sub> [mm]	h <sub>g'</sub> [mm]	B <sub>i</sub> [mm]*	B <sub>k</sub> [mm]	KR [mm]				q <sub>k</sub> [kg/m]
87	117	127.5	100 – 800	B <sub>i</sub> + 70	250	310	360	500	10.37 – 17.47

\* in 1 mm width sections

### Order example



TKHD90

Type

400

B<sub>i</sub> [mm]

RMF

Stay variant

310

KR [mm]

2700

L<sub>k</sub> [mm]

VS

Stay arrangement

### Divider systems

As a standard, the divider system is mounted on every 4<sup>th</sup> chain link on the inside plate.

As a standard, dividers and the complete divider system (dividers with height separations) can be moved in the cross section (**version A**).

For applications with lateral acceleration and free hanging on the side, the dividers can be attached by simple insertion of a fixing profile into the RMF stay, available as an accessory (**version B**).

### Divider system TSO without height separation

Vers.	a <sub>T</sub> min [mm]	a <sub>X</sub> min [mm]	a <sub>C</sub> min [mm]	a <sub>X</sub> grid [mm]	n <sub>T</sub> min
A	10	20	15	-	-
B	12.5	20	15	5	-

The dividers can be moved within the cross section (version A) or fixed (version B).

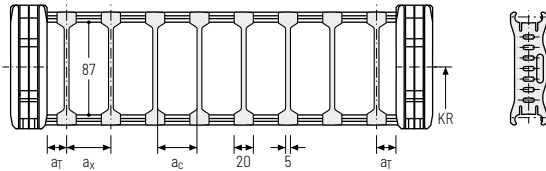

### Divider system TS1 with continuous height separation

Vers.	a <sub>T</sub> min [mm]	a <sub>X</sub> min [mm]	a <sub>C</sub> min [mm]	a <sub>X</sub> grid [mm]	n <sub>T</sub> min
A	10	20	15	-	2
B	12.5	20	15	5	2

The dividers can be moved within the cross section (version A) or fixed (version B).

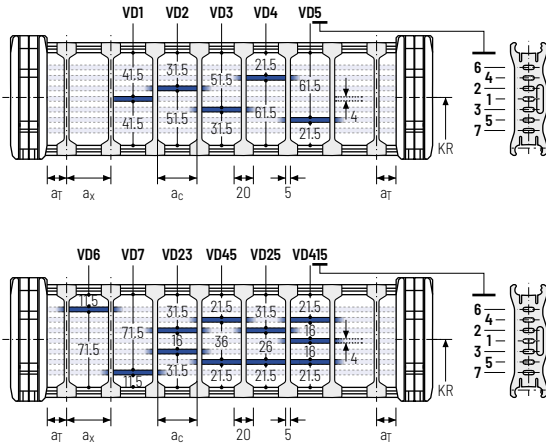

### Order example

🛒

TS1
·
A
·
3
-
VD1

⋮

-
VD3

Divider system
Version
n<sub>T</sub>
Height separation

Please state the designation of the divider system (**TS0, TS1,...**), the version, and the number of dividers per cross section [n<sub>T</sub>].

When using divider systems with height separation (**TS1**), please additionally state the position (e.g. VD1) viewed from the left driver belt. You are welcome to add a sketch to your order.

PROTUM® series
K series
UNIFLEX Advanced series
M series
TKHD series
XL series
QUANTUM® series
TKR series
TKA series
UAT series

## End connectors - steel short

The connection variants on the fixed point and on the driver can be combined and changed later on, if necessary.

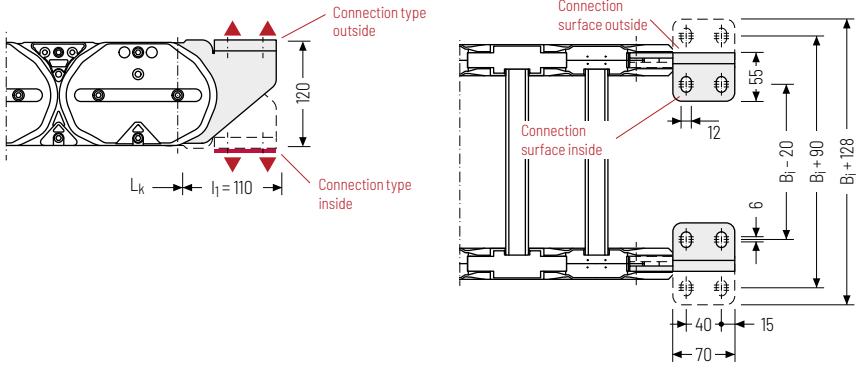

▲ Assembly options

### Connection point

- F** - fixed point
- M** - driver

### Connecting surface

- A** - connecting surface outside
- I** - connecting surface inside

### Connection type

- A** - threaded joint outside (standard)
- I** - threaded joint inside

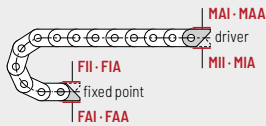

## Order example



Steel	F	A	I
Steel	M	A	I
End connector	Connection point	Connection type	Connecting surface



We recommend the use of strain reliefs at the driver and fixed point. See from p. 908.

## End connectors LF - steel long

The connection variants on the fixed point and on the driver can be combined and changed later on, if necessary.

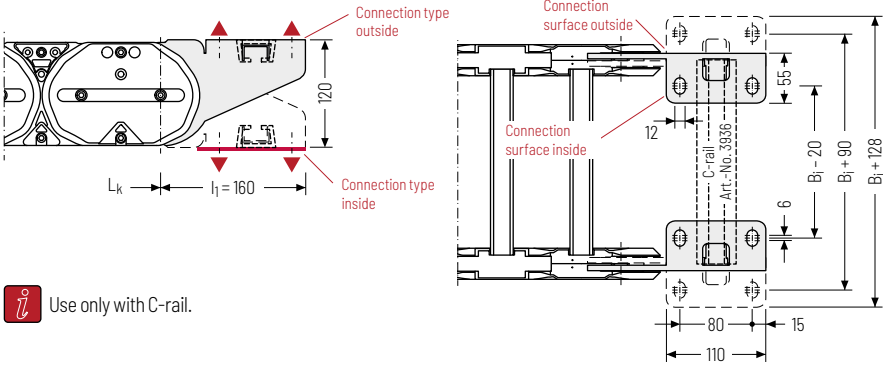

Use only with C-rail.

▲ Assembly options

### Connection point

- F - fixed point
- M - driver

### Connecting surface

- A - connecting surface outside
- I - connecting surface inside

### Connection type

- A - threaded joint outside (standard)
- I - threaded joint inside

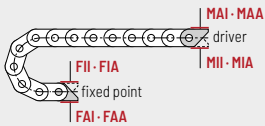

## Order example

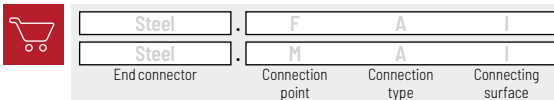

## Additional product information online



Installation instructions, etc.:  
Additional info via your smartphone or check online at [tsubaki-kabelschlepp.com/downloads](http://tsubaki-kabelschlepp.com/downloads)



Configure your cable carrier here:  
[online-engineer.de](http://online-engineer.de)



# TKHD85-R

## Heavy-duty cable carrier with integrated roller



**Pitch**  
85 mm



**Inner height**  
58 mm



**Inner widths**  
100 - 800 mm



**Bending radii**  
240 - 400 mm

Stainless steel ball bearings with application-specific lubrication and plastic rollers ensure quiet and smooth operation. Integrated, wear-free damping systems minimize the mechanical load for the entire system.

- » suitable for all long travel applications
- » quiet and low-vibration operation
- » space-saving and cost-optimized
- » long service life - low maintenance
- » easy access to rollers
- » minimized loads on cable carrier and cables
- » low push and pull forces
- » high travel speed and acceleration
- » large additional loads possible
- » retrofit of existing systems
- » exchange other makes up to 100 %
- » integration of existing guide channels

### Stay variants



**Aluminum stay RMF** ..... page 472

#### Frame stay, solid

- » Aluminum profile bars for heavy loads and large cable carrier widths. Easy threaded connection.
- » **Inside/outside:** Threaded joint easy to release.

## Rolling arrangement | Cable carrier with integrated roller

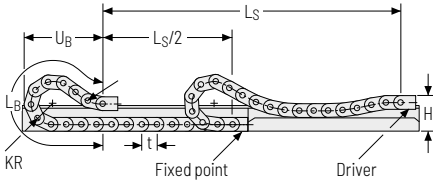

KR [mm]	H [mm]	G0 module RKR [mm]	L <sub>B</sub> [mm]	U <sub>B</sub> [mm]	q <sub>z</sub> max [kg/m]
240	252	375	2410	1050	60
300	252	375	2920	1270	60
350	252	375	3380	1450	40
400	252	375	3855	1630	20



**Speed**  
up to 5 m/s



**Acceleration**  
up to 50 m/s<sup>2</sup>



**Travel length**  
up to 1200 m



**Additional load**  
up to 50 kg/m



The rolling cable carrier must be guided in a channel.  
See p. 850.

The G0 module mounted on the driver is a defined sequence of 6 adapted KR/RKR link plates.



Our technical support can provide help for rolling arrangements:  
[technik@kabelschlepp.de](mailto:technik@kabelschlepp.de)

PROTUM® series
K series
UNIFLEX Advanced series
M series
<b>TKHD series</b>
XL series
QUANTUM® series
TKR series
TKA series
UAT series

## Aluminum stay RMF – frame stay solid

- » Aluminum profile bars for heavy loads and large cable carrier widths.
- » Available customized in **1 mm grid**.
- » **Inside/outside:** Threaded joint easy to release.



Stay arrangement on each chain link (**VS: fully-stayed**)



**1 mm** B<sub>i</sub> 100 – 800 mm  
in 1 mm width sections

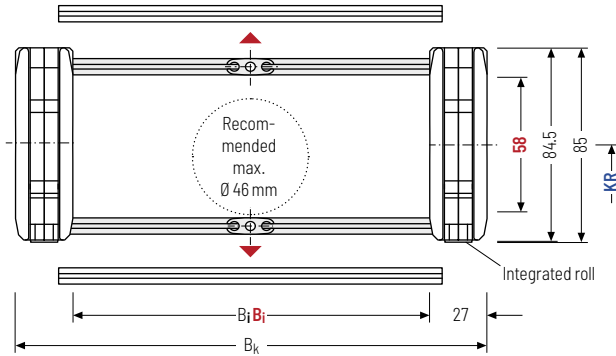

The maximum cable diameter strongly depends on the bending radius and the desired cable type. Please contact us.

### Calculating the cable carrier length

#### Cable carrier length $L_k$

$$L_k \approx \frac{L_S}{2} + L_B$$

Cable carrier length  $L_k$   
rounded to pitch  $t$  for odd  
number of chain links

$h_i$ [mm]	$h_G$ [mm]	$h_G'$ [mm]	$B_i$ [mm]*	$B_k$ [mm]	$KR$ [mm]				$q_k$ [kg/m]
58	84.5	85	100 – 800	$B_i + 54$	240	300	350	400	6.021 – 13.119

\* in 1 mm width sections

### Order example



TKHD85-R

Type

400

$B_i$  [mm]

RMF

Stay variant

300

$KR$  [mm]

2125

$L_k$  [mm]

VS

Stay arrangement

**Divider systems**

As a standard, the divider system is mounted on every 2<sup>nd</sup> chain link on the inside plate.

As a standard, dividers and the complete divider system (dividers with height separations) can be moved in the cross section (**version A**).

For applications with lateral acceleration and free hanging on the side, the dividers can be attached by simple insertion of a fixing profile into the RMF stay, available as an accessory (**version B**).

**Divider system TSO without height separation**

Vers.	a <sub>T</sub> min [mm]	a <sub>X</sub> min [mm]	a <sub>C</sub> min [mm]	a <sub>X</sub> grid [mm]	n <sub>T</sub> min
A	10	20	16	-	-
B	10	20	16	5	-

The dividers can be moved within the cross section (version A) or fixed (version B).

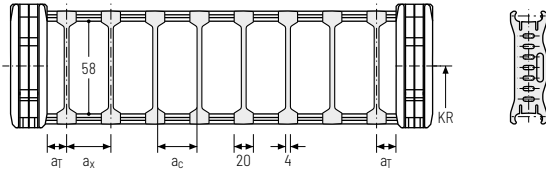

**Divider system TS1 with continuous height separation**

Vers.	a <sub>T</sub> min [mm]	a <sub>X</sub> min [mm]	a <sub>C</sub> min [mm]	a <sub>X</sub> grid [mm]	n <sub>T</sub> min
A	10	20	16	-	2
B	10	20	16	5	2

The dividers can be moved within the cross section (version A) or fixed (version B).

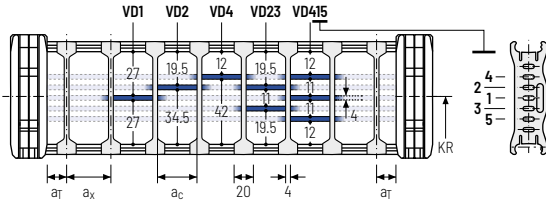

**Order example**

TS1

A

3

VD1

⋮

VD3

Divider system

Version

n<sub>T</sub>

Height separation

Please state the designation of the divider system (**TS0, TS1,...**), the version, and the number of dividers per cross section [n<sub>T</sub>].

When using divider systems with height separation (**TS1**), please additionally state the position (e.g. VD1) viewed from the left driver belt. You are welcome to add a sketch to your order.

PROTUM® series
K series
UNIFLEX Advanced series
M series
TKHD series
XL series
QUANTUM® series
TKR series
TKA series
UAT series

## End connectors - steel short

The connection variants on the fixed point and on the driver can be combined and changed later on, if necessary.

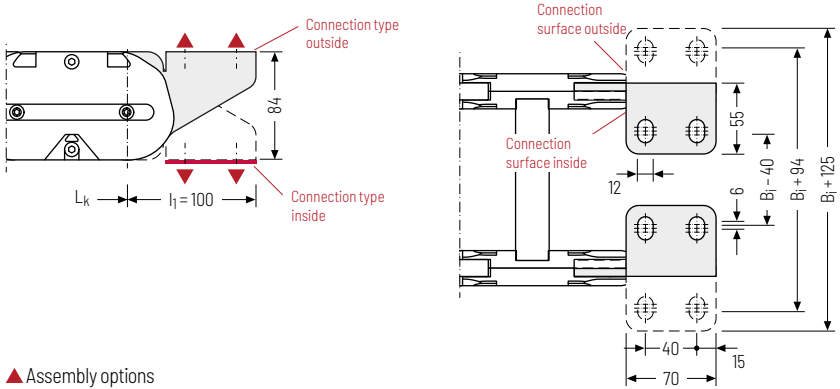

▲ Assembly options

### Connection point

- F - fixed point
- M - driver

### Connecting surface

- A - connecting surface outside
- I - connecting surface inside

### Connection type

- A - threaded joint outside (standard)
- I - threaded joint inside

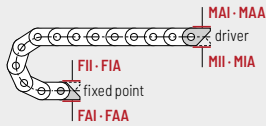

## Order example



Steel	F	A	I
Steel	M	A	I
End connector	Connection point	Connection type	Connecting surface



We recommend the use of strain reliefs at the driver and fixed point. See from p. 908.

## End connectors LF - steel long

The connection variants on the fixed point and on the driver can be combined and changed later on, if necessary.

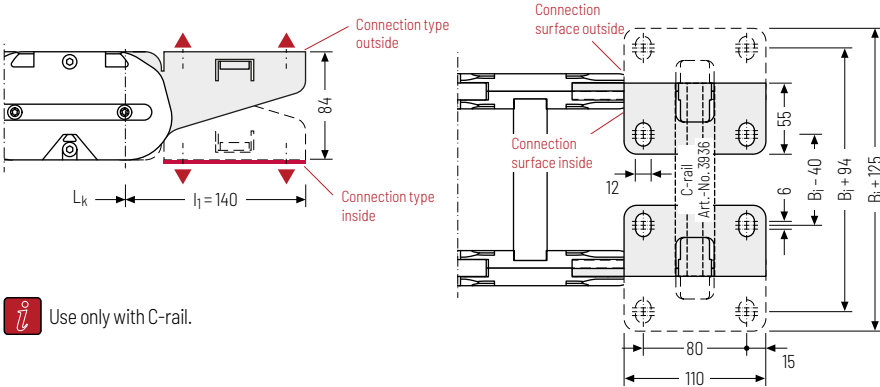

Use only with C-rail.

Assembly options

### Connection point

- F - fixed point
- M - driver

### Connecting surface

- A - connecting surface outside
- I - connecting surface inside

### Connection type

- A - threaded joint outside (standard)
- I - threaded joint inside

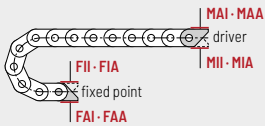

## Order example

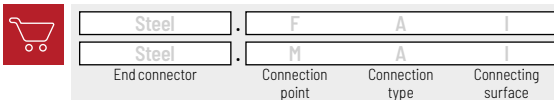

## Additional product information online



Installation instructions, etc.:  
Additional info via your smartphone or check online at [tsubaki-kabelschlepp.com/downloads](http://tsubaki-kabelschlepp.com/downloads)



Configure your cable carrier here:  
[online-engineer.de](http://online-engineer.de)

PROTUM® series

K series

UNIFLEX Advanced series

M series

TKHD series

XL series

QUANTUM® series

TKR series

TKA series

UAT series

# TKHD90-R

## Heavy-duty cable carrier with integrated roller



**Pitch**  
90 mm



**Inner height**  
87 mm



**Inner widths**  
100 - 800 mm



**Bending radii**  
250 - 500 mm

Stainless steel ball bearings with application-specific lubrication and plastic rollers ensure quiet and smooth operation. Integrated, wear-free damping systems minimize the mechanical load for the entire system.

- » suitable for all long travel applications
- » quiet and low-vibration operation
- » space-saving and cost-optimized
- » long service life - low maintenance
- » easy access to rollers
- » minimized loads on cable carrier and cables
- » low push and pull forces
- » high travel speed and acceleration
- » large additional loads possible
- » retrofit of existing systems
- » exchange other makes up to 100 %
- » integration of existing guide channels

### Stay variants



**Aluminum stay RMF** ..... page 478

#### Frame stay, solid

- » Aluminum profile bars for heavy loads and large cable carrier widths. Easy threaded connection.
- » **Inside/outside:** Threaded joint easy to release.

## Rolling arrangement | Cable carrier with integrated roller

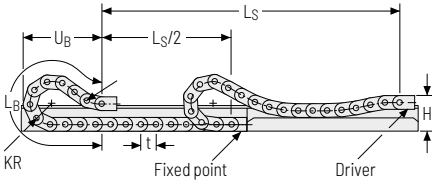

KR [mm]	H [mm]	G0 module RKR [mm]	L <sub>B</sub> [mm]	U <sub>B</sub> [mm]	q <sub>z</sub> max [kg/m]
250	351	600	2420	1090	100
310	351	600	2780	1208	100
360	351	600	3230	1380	90
500	351	600	4400	1820	75



**Speed**  
up to 10 m/s



**Acceleration**  
up to 50 m/s<sup>2</sup>



**Travel length**  
up to 1500 m



**Additional load**  
up to 100 kg/m



The rolling cable carrier must be guided in a channel.  
See p. 850.

The G0 module mounted on the driver is a defined sequence of 6 adapted KR/RKR link plates.



Our technical support can provide help for rolling arrangements:  
[technik@kabelschlepp.de](mailto:technik@kabelschlepp.de)

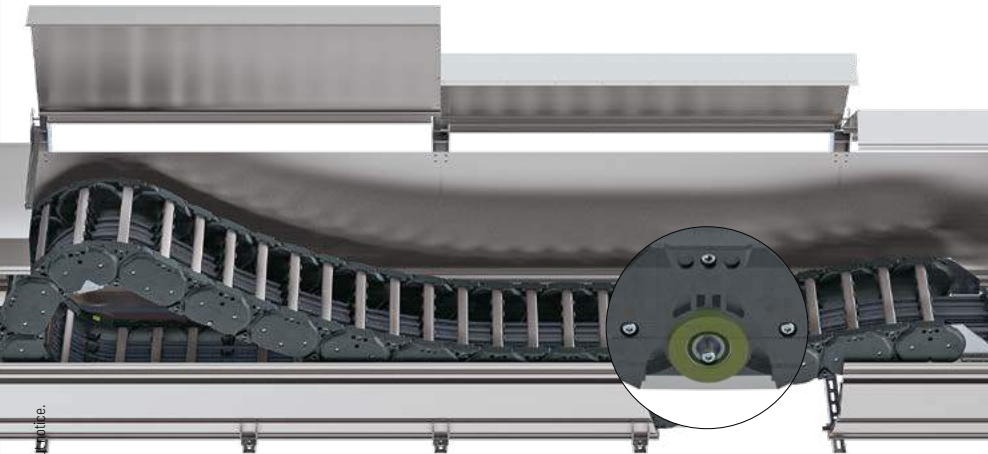



## Aluminum stay RMF – frame stay solid

- » Aluminum profile bars for heavy loads and large cable carrier widths.
- » Available customized in **1 mm grid**.
- » **Inside/outside:** Threaded joint easy to release.



Stay arrangement on each chain link (**VS: fully-stayed**)



**1 mm** B<sub>i</sub> 100 – 800 mm  
in 1 mm width sections

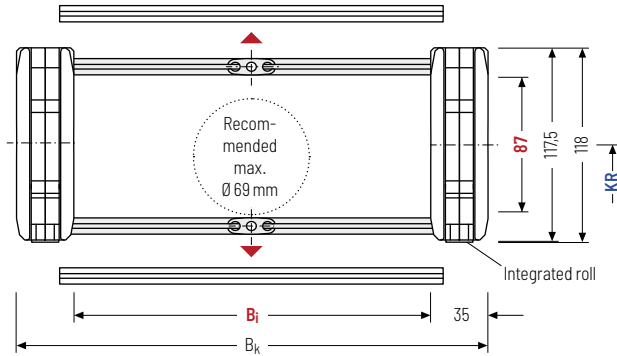

The maximum cable diameter strongly depends on the bending radius and the desired cable type. Please contact us.

### Calculating the cable carrier length

#### Cable carrier length L<sub>k</sub>

$$L_k \approx \frac{L_S}{2} + L_B$$

Cable carrier length L<sub>k</sub> rounded to pitch t for odd number of chain links

h <sub>i</sub> [mm]	h <sub>G</sub> [mm]	h <sub>G'</sub> [mm]	B <sub>i</sub> [mm]*	B <sub>k</sub> [mm]	KR [mm]			q <sub>k</sub> [kg/m]	
87	117.5	118	100 – 800	B <sub>i</sub> + 70	250	310	360	500**	10.37 – 17.47

\* in 1 mm width sections \*\* When using this KR please contact our technical support.

### Order example



TKHD90-R

Type

400

B<sub>i</sub> [mm]

RMF

Stay variant

310

KR [mm]

2700

L<sub>k</sub> [mm]

VS

Stay arrangement

**Divider systems**

As a standard, the divider system is mounted on every 2<sup>nd</sup> chain link on the inside plate.

For applications with lateral acceleration and free hanging on the side, the dividers can be attached by simple insertion of a fixing profile into the RMF stay, available as an accessory (**version B**).

As a standard, dividers and the complete divider system (dividers with height separations) can be moved in the cross section (**version A**).

**Divider system TSO without height separation**

Vers.	a <sub>T</sub> min [mm]	a <sub>X</sub> min [mm]	a <sub>C</sub> min [mm]	a <sub>X</sub> grid [mm]	n <sub>T</sub> min
A	10	20	15	-	-
B	12.5	20	15	5	-

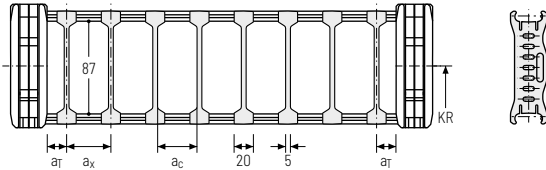

The dividers can be moved within the cross section (version A) or fixed (version B).

**Divider system TS1 with continuous height separation**

Vers.	a <sub>T</sub> min [mm]	a <sub>X</sub> min [mm]	a <sub>C</sub> min [mm]	a <sub>X</sub> grid [mm]	n <sub>T</sub> min
A	10	20	15	-	2
B	12.5	20	15	5	2

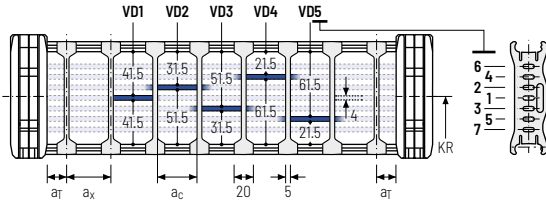

The dividers can be moved within the cross section (version A) or fixed (version B).

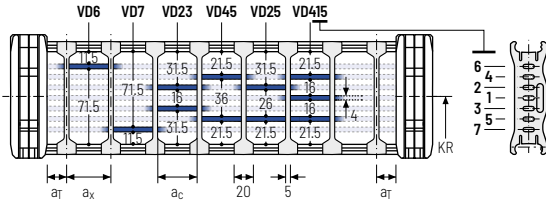

**Order example**

TS1

·

A

·

3

-

VD1

⋮

-

VD3

Divider system
Version
n<sub>T</sub>
Height separation

Please state the designation of the divider system (**TS0, TS1,...**), the version, and the number of dividers per cross section [n<sub>T</sub>].

When using divider systems with height separation (**TS1**), please additionally state the position (e.g. VD1) viewed from the left driver belt. You are welcome to add a sketch to your order.

PROTUM® series
K series
UNIFLEX Advanced series
M series
<b>TKHD series</b>
XL series
QUANTUM® series
TKR series
TKA series
UAT series

## End connectors - steel short

The connection variants on the fixed point and on the driver can be combined and changed later on, if necessary.

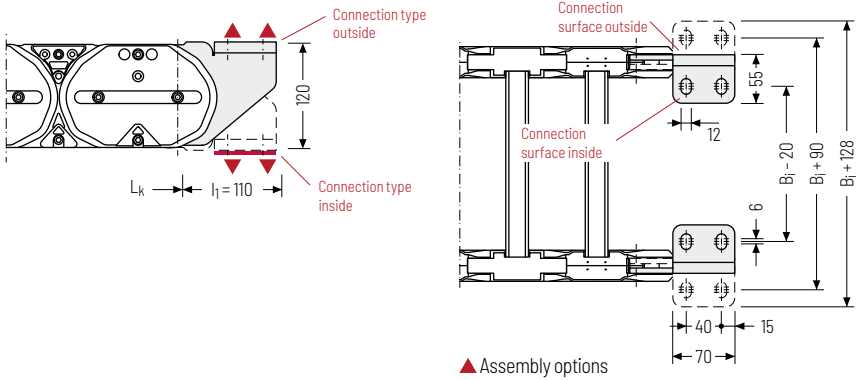

### Connection point

- F - fixed point
- M - driver

### Connecting surface

- A - connecting surface outside
- I - connecting surface inside

### Connection type

- A - threaded joint outside (standard)
- I - threaded joint inside

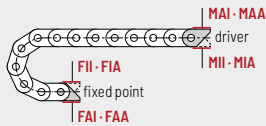

## Order example



Steel	F	A	I
Steel	M	A	I
End connector	Connection point	Connection type	Connecting surface



We recommend the use of strain reliefs at the driver and fixed point. See from p. 850.

## End connectors LF - steel long

The connection variants on the fixed point and on the driver can be combined and changed later on, if necessary.

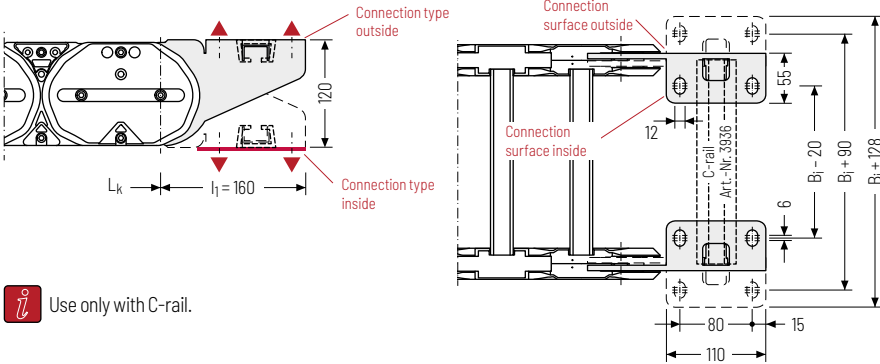

▲ Assembly options

### Connection point

- F - fixed point
- M - driver

### Connecting surface

- A - connecting surface outside
- I - connecting surface inside

### Connection type

- A - threaded joint outside (standard)
- I - threaded joint inside

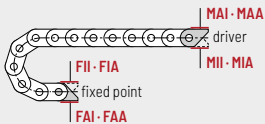

## Order example

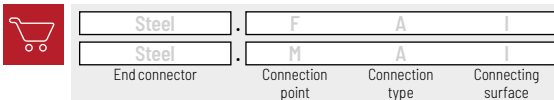

## Additional product information online



Installation instructions, etc.:  
Additional info via your smartphone or check online at [tsubaki-kabelschlepp.com/downloads](http://tsubaki-kabelschlepp.com/downloads)



Configure your cable carrier here:  
[online-engineer.de](http://online-engineer.de)