

XL series

Cable carrier with
large inside height



Trademarks are legally protected for the TSUBAKI KABELSCHLEPP GmbH
as a national or international registration in the following countries:
tsubaki-kabelschlepp.com/Trademarks

Subject to change.

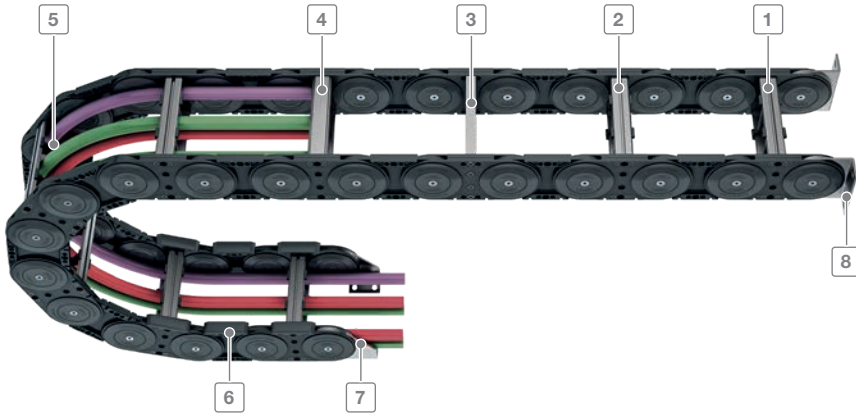

Inner heights



Inner widths



- 1 Aluminum stays available in **1 mm width sections**
- 2 Aluminum stays with 4 screw-fixing points for extreme loads
- 3 Aluminum hole stays
- 4 Plastic rolling stays
- 5 Can be opened on the inside and the outside for installation of cables and hoses
- 6 Replaceable glide shoes
- 7 Sturdy end connectors made of steel
- 8 Flange connection

Features

- Sizes/dimensions
- Low intrinsic weight
- Optimum force transmission via the large-surface stroke system (2 disc principle)
- Plastic side bands in combination with aluminum stays
- Versions with aluminum stays available in 1 mm width sections up to 1000 mm inner width
- Can be opened on both sides
- Large selection of stay systems and separating options for cables
- Optionally with strain relief



Bolted stays for maximum stability even for large cable carrier widths



Replaceable glide shoes for long service life for gliding applications



Sturdy end connectors made of steel (different connection variants)



Many separation options for the cables

Key for abbreviations on page 16

Type	Opening variant	Stay variant	h_i [mm]	h_G [mm]	B_i [mm]	B_k [mm]	B_i - grid [mm]	t [mm]	KR [mm]	Additional load ≤ [kg/m]	Cable- d _{max} [mm]
XLC 1650											
		RM	108	140	200–1000	$B_i + 68$	1	165	250–550	65	86
		LG	110	140	200–1000	$B_i + 68$	1	165	250–550	65	88
		RMR	108	140	200–1000	$B_i + 68$	1	165	250–550	65	84

* Further information on request.

Design guidelines from page 64

Technical support: technik@kabelschlepp.de

online-engineer.de
Cable Carrier Configurator



XLT series

Also available as covered versions with covers system. More information can be found in chapter "XLT series" from page 610.

XL series | Overview

Unsupported arrangement			Gliding arrangement			Inner distribution				Installation variants			Page
Travel length \leq [m]	v_{max} \leq [m/s]	a_{max} \leq [m/s ²]	Travel length \leq [m]	v_{max} \leq [m/s]	a_{max} \leq [m/s ²]	TS0	TS1	TS2	TS3	vertical hanging or standing	lying on the side	rotating arrangement	
11.75	4	25	350	2	2-3	●	-	-	●	●	●	●	434
11.75	4	25	350	2	2-3	-	-	-	-	●	●	●	*
11.75	4	25	350	2	2-3	●	-	-	-	●	●	●	*

Inner heights



Inner widths



tsubaki-kabelschlepp.com/xl

XL1650

Key for abbreviations
on page 16



Stay variants

Design guidelines
from page 64



Aluminum stay RM page 434

Frame stay, solid

- Aluminum profile bars for heavy loads and maximum cable carrier widths. Double threaded joints on both sides "Heavy Duty".
- **Inside/outside:** Threaded joints easy to release.

Technical support:
technik@kabelschlepp.de

online-engineer.de
Cable Carrier Configurator

Additional stay variants on request



Aluminum stay LG
Optimum cable routing in the neutral bending line.



Aluminum stay RMR
Gentle cable guiding with rollers.

Unsupported arrangement

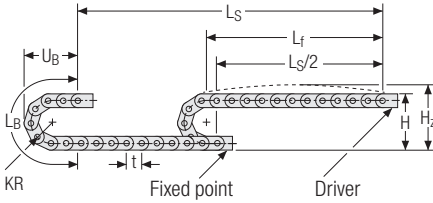

KR [mm]	H [mm]	H _z [mm]	L _B [mm]	U _B [mm]
250	640	740	950	403
300	740	840	1107	453
350	840	940	1264	503
400	940	1040	1421	553
450	1040	1140	1578	603
500	1140	1240	1735	653
550	1240	1340	1892	703

Inner heights



Inner widths



Load diagram for unsupported length depending on the additional load.

Sagging of the cable carrier is technically permitted for extended travel lengths, depending on the specific application.

Intrinsic cable carrier weight $q_k = 13 \text{ kg/m}$. For other inner widths, the maximum additional load changes.

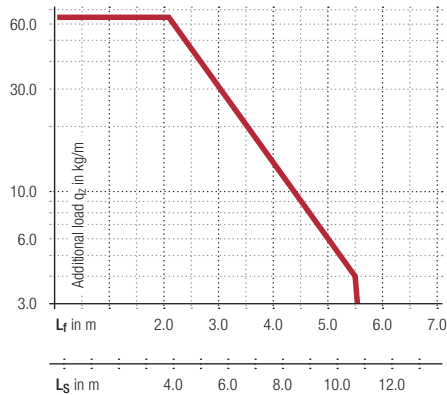

Speed
up to 4 m/s



Acceleration
up to 25 m/s²



Travel length
up to 11.75 m



Additional load
up to 65 kg/m

Gliding arrangement

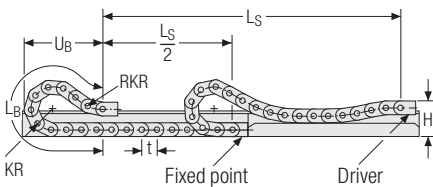

Speed
up to 2 m/s



Acceleration
up to 2 – 3 m/s²



Travel length
up to 350 m



Additional load
up to 65 kg/m



The gliding cable carrier must be guided in a channel. See p. 782.

We recommend the use of glide shoes for gliding applications.



Our technical support can provide help for gliding arrangements:
technik@kabelschlepp.de

Aluminum stay RM – Frame stay, solid

- Aluminum profile bars for heavy loads and maximum cable carrier widths. Double threaded joints on both sides “Heavy Duty”.
- Available customized in **1 mm grid**.
- **Inside/outside:** Threaded joints easy to release.

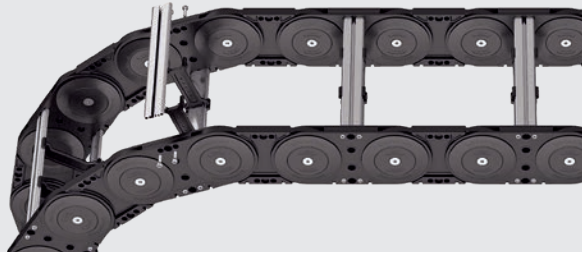

HEAVY DUTY
TSUBAKI KABELSCHLEPP

Key for abbreviations
on page 16

Design guidelines
from page 64

Technical support:
technik@kabelschlepp.de



Stay arrangement on every 2nd chain link, **standard** (HS: half-stayed)



Stay arrangement on each chain link (**VS: fully-stayed**)



1 mm B_i 200 – 1000 mm in **1 mm** width sections

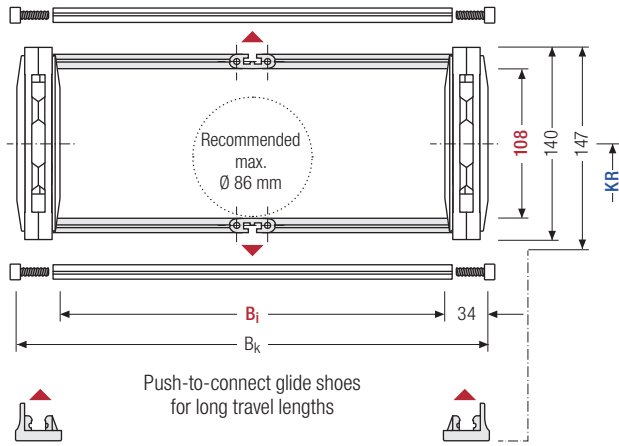

i The maximum cable diameter strongly depends on the bending radius and the desired cable type. Please contact us.

Calculating the cable carrier length

Cable carrier length L_k

$$L_k \approx \frac{L_S}{2} + L_B$$

Cable carrier length L_k rounded to pitch t for odd number of chain links

h _i [mm]	h _G [mm]	h _{G'} [mm]	B _i [mm]*	B _k [mm]	KR [mm]					q _k [kg/m]		
108	140	147	200 – 1000	B _i + 68	250	300	350	400	450	500	550	10.5 – 15.3

* in 1 mm width sections

Order example

XLC1650 ·
 600 ·
 RM ·
 350 ·
 4125 ·
 HS
 Type B_i [mm] Stay variant KR [mm] L_k [mm] Stay arrangement

Divider systems

The divider system is mounted on each crossbar as a standard – on every 2nd chain link for stay mounting (HS).

As a standard, dividers or the complete divider system (dividers with height separations) are movable in the cross section (**version A**).

Inner heights



Inner widths



Increments



tsubaki-kabelschlepp.com/xl

Divider system TS0 without height separation

Vers.	a _T min [mm]	a _x min [mm]	a _c min [mm]	n _T min
A	6	25	17	–

The dividers can be moved in the cross section.

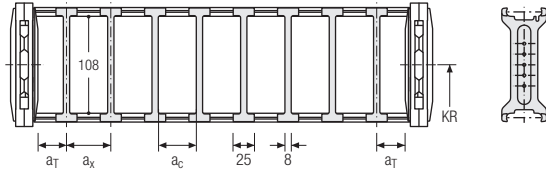

Divider system TS3 with height separation consisting of plastic partitions

Vers.	a _T min [mm]	a _x min [mm]	a _c min [mm]	n _T min
A	1	16 / 42*	8	2

* For aluminum partitions

The dividers are fixed with the partitions. The entire divider system can be moved in the cross section.

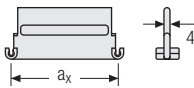
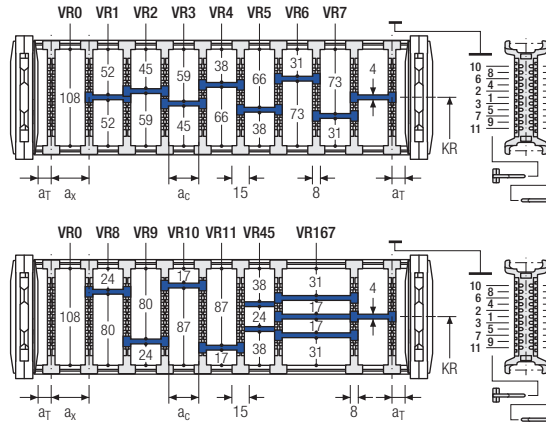

Aluminum partitions in 1 mm increments with a_x > 42 mm are also available.

a _x (center distance of dividers) [mm]	
a _c (nominal width of inner chamber) [mm]	
16	18
23	28
32	33
38	43
48	58
64	68
8	10
15	20
24	25
30	35
40	50
56	60
78	80
88	96
112	128
144	160
176	192
208	208
70	72
80	88
104	120
136	152
168	184
200	200

When using plastic partitions with a_x > 112 mm, we recommend an additional center support with a twin divider (S_T = 5 mm). Twin dividers are also suitable for retrofitting in the partition system.

Order example

TS3

A

3

K1

34

VR1

K4

38

VR3

Divider system
Version
n_T
Chamber
a_x
Height separation

Please state the designation of the divider system (**TS0, TS3**), the version, and the number of dividers per cross section [n_T]. In addition, please also enter the chambers [K] from left to right, as well as the assembly distances [a_T/a_x].

XL1650 | End connectors

End connectors – steel

End connectors made of steel. The connection variants on the fixed point and on the driver can be combined and changed later on, if necessary.

Key for abbreviations on page 16

Design guidelines from page 64

Technical support: technik@kabelschlepp.de

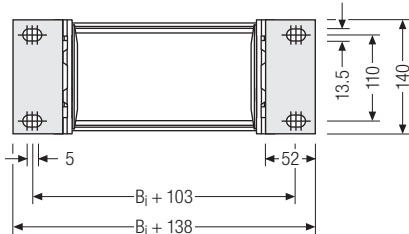
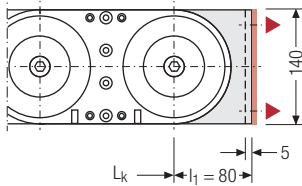
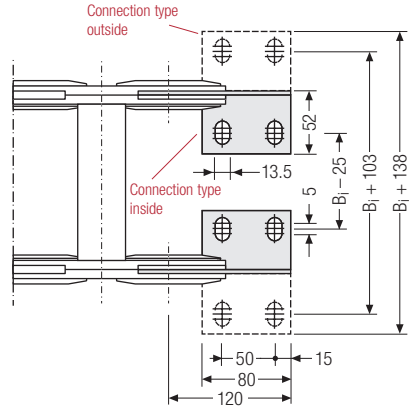
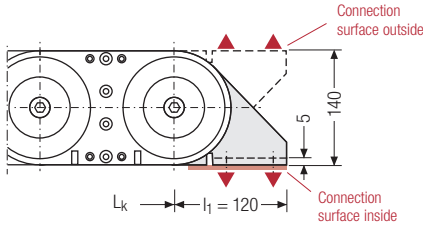

▲ Assembly options

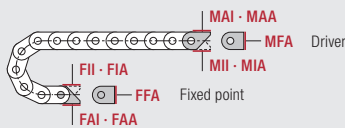

Connection point

- F** – fixed point
- M** – driver

Connection surface

- I** – connection surface inside
- A** – connection surface outside

Connection type

- A** – threaded joint outside (standard)
- I** – threaded joint inside
- F** – flange connection

Order example

	Steel	.	F	A	I
	Steel	.	M	A	I
	End connector		Connection point	Connection type	Connection surface



We recommend the use of strain reliefs before driver and fixed point. See from p. 834.



XL series

Inner heights



Inner widths



tsubaki-kabelschlepp.com/xl

Subject to change.