

XLT series

Tubes with variable
cable carrier widths

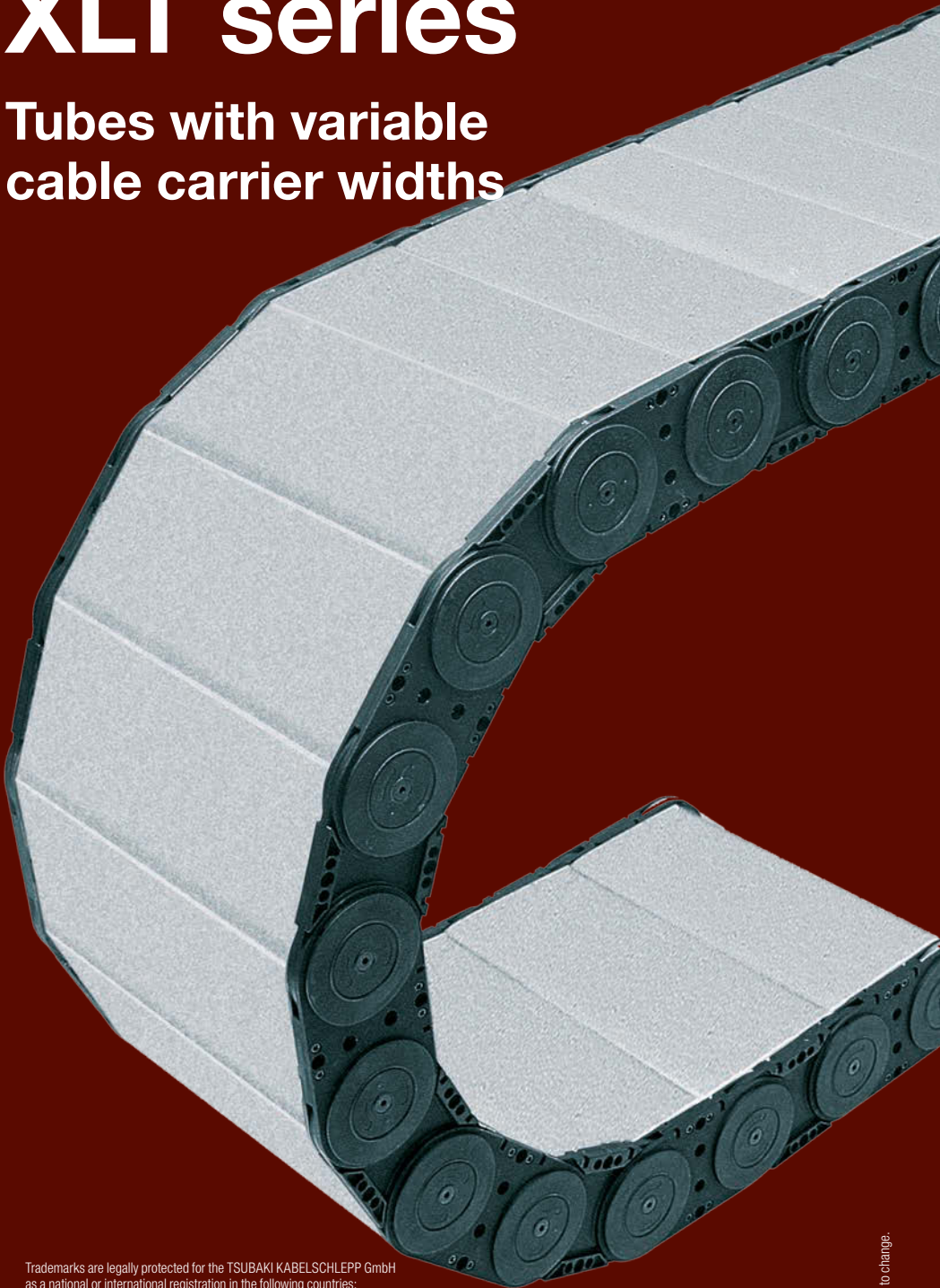

Trademarks are legally protected for the TSUBAKI KABELSCHLEPP GmbH
as a national or international registration in the following countries:
tsubaki-kabelschlepp.com/Trademarks

Subject to change.

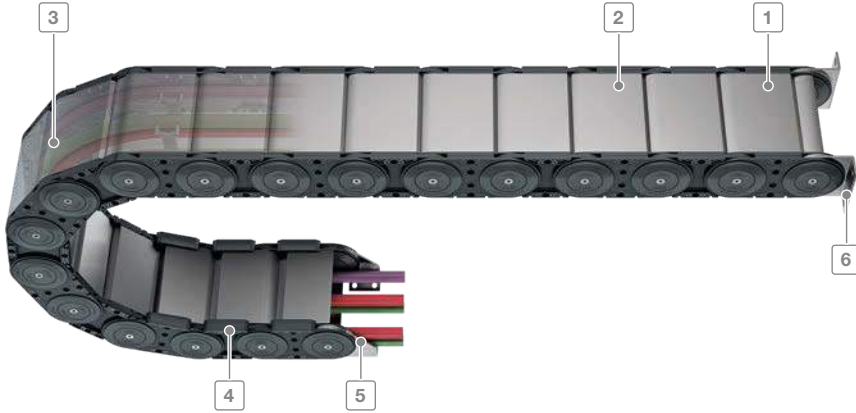

Inner heights



Inner widths



- 1 Aluminum covers available in **1 mm width sections**
- 2 4 screw-fixing points for extreme loads
- 3 Can be opened on the inside and the outside for installation of cables and hoses
- 4 Replaceable glide shoes
- 5 Sturdy end connectors made of steel
- 6 Flange connection

tsubaki-kabelschlepp.com/xlt

Features

- Sizes/dimensions
- Low intrinsic weight
- Optimum force transmission via the large-surface stroke system (2 disc principle)
- Plastic side bands in combination with aluminum stays
- Versions with aluminum stays available in 1 mm width sections up to 1000 mm inner width
- Can be opened on both sides
- Large selection of separating options for cables and hoses
- Optionally with strain relief



Bolted covers systems for maximum stability even for large cable carrier widths



Replaceable glide shoes for long service life for gliding applications



Sturdy end connectors made of steel (different connection variants)



Many separation options for the cables

Key for abbreviations
on page 16

Design guidelines
from page 62

Technical support:
technik@kabelschlepp.de



Type	Opening variant	Stay variant	h_i [mm]	h_G [mm]	B_i [mm]	B_k [mm]	B_i - grid [mm]	t [mm]	KR [mm]	Additional load ≤ [kg/m]	Cable- d _{max} [mm]
XLT1650											
		RMD	105	140	200 – 1000	$B_i + 68$	1	165	300 – 550	65	84

XLT series | Overview

Unsupported arrangement			Gliding arrangement			Inner distribution				Installation variants			Page	
Travel length \leq [m]	$v_{max} \leq$ [m/s]	$a_{max} \leq$ [m/s ²]	Travel length \leq [m]	$v_{max} \leq$ [m/s]	$a_{max} \leq$ [m/s ²]	TS0	TS1	TS2	TS3	vertical hanging or standing	lying on the side	rotating arrangement		
										•	•	•	-	570
11.75	4	25	350	2	2-3	•	-	-	•	•	•	-		

Inner heights



Inner widths



tsubaki-kabelschlepp.com/xlt

XLT1650

Key for abbreviations
on page 16



Pitch
165 mm



Inner heights
105 mm



Inner widths
200 – 1000 mm



Bending radii
300 – 550 mm

Stay variants



Aluminum stay RMD page 570

Aluminum cover system

- Bolted aluminum covers for maximum stability
- For applications generating swarf or coarse contamination
- **Inside/outside:** Threaded joint easy to release.

Design guidelines
from page 62

Technical support:
technik@kabelschlepp.de

Unsupported arrangement

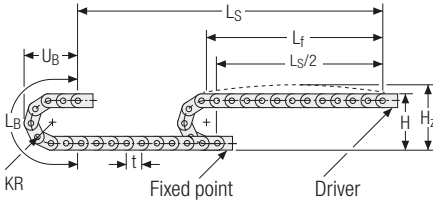

KR [mm]	H [mm]	H _z [mm]	L _B [mm]	U _B [mm]
300	740	840	1107	453
350	840	940	1264	503
400	940	1040	1421	553
450	1040	1140	1578	603
500	1140	1240	1735	653
550	1240	1340	1892	703

Inner heights



Inner widths



Load diagram for unsupported length depending on the additional load.

Sagging of the cable carrier is technically permitted for extended travel lengths, depending on the specific application.

Intrinsic cable carrier weight $q_k = 13 \text{ kg/m}$. For other inner widths, the maximum additional load changes.

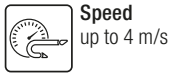
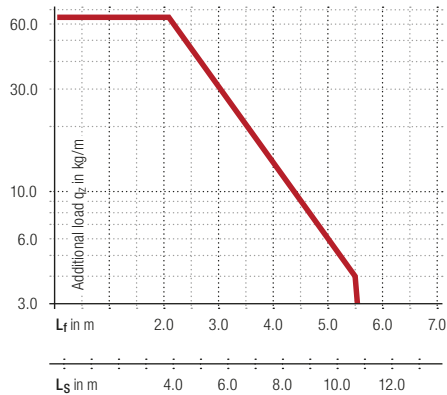

tsubaki-kabelschlepp.com/xlt

Gliding arrangement

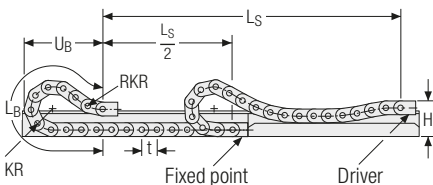

The gliding cable carrier must be guided in a channel. See p. 732.

We recommend the use of glide shoes for gliding applications.

Aluminum stay RMD – aluminum cover system

- Bolted aluminum covers for maximum stability
- For applications generating swarf or coarse contamination
- Available customized in **1 mm grid**.
- **Inside/outside:** Threaded joint easy to release.





Key for abbreviations on page 16

Design guidelines from page 62

Technical support: technik@kabelschlepp.de

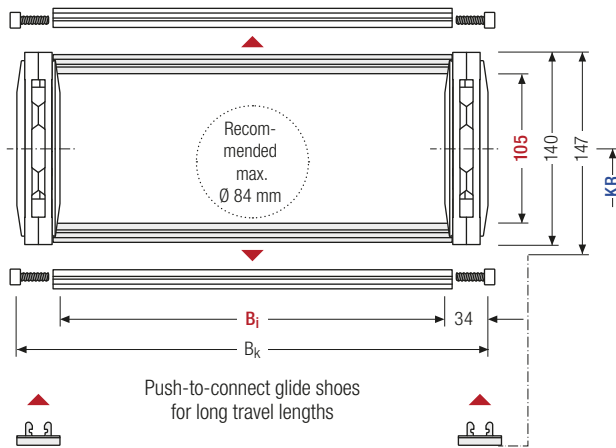
 Stay arrangement on each chain link (**VS: fully-stayed**)  B_i 200 – 1000 mm in 1 mm width sections



 The maximum cable diameter strongly depends on the bending radius and the desired cable type. Please contact us.

Calculating the cable carrier length

Cable carrier length L_k

$$L_k \approx \frac{L_S}{2} + L_B$$

Cable carrier length L_k rounded to pitch t for odd number of chain links

h_i [mm]	h_G [mm]	h_G' [mm]	B_i [mm]*	B_k [mm]	KR [mm]						q_k [kg/m]
105	140	147	200 – 1000	$B_i + 68$	300	350	400	450	500	550	10.5 – 15.3

* in 1 mm width sections

Order example

 **XLT1650** Type · **420** B_i [mm] · **RMD** Stay variant · **350** KR [mm] · **2850** L_k [mm] · **VS** Stay arrangement

Divider systems

The divider system is mounted on each crossbar as a standard – on every 2nd chain link for stay mounting (HS).

As a standard, dividers or the complete divider system (dividers with height separations) are movable in the cross section (**version A**).

Inner heights



Inner widths



Divider system TS0 without height separation

Vers.	a _T min [mm]	a _x min [mm]	a _c min [mm]	n _T min
A	6	25	17	–

The dividers can be moved in the cross section.

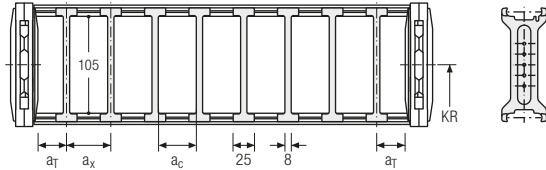

Divider system TS3 with height separation consisting of plastic partitions

Vers.	a _T min [mm]	a _x min [mm]	a _c min [mm]	n _T min
A	1	16 / 42*	8	2

* For aluminum partitions

The dividers are fixed with the partitions. The entire divider system can be moved in the cross section.

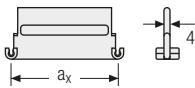
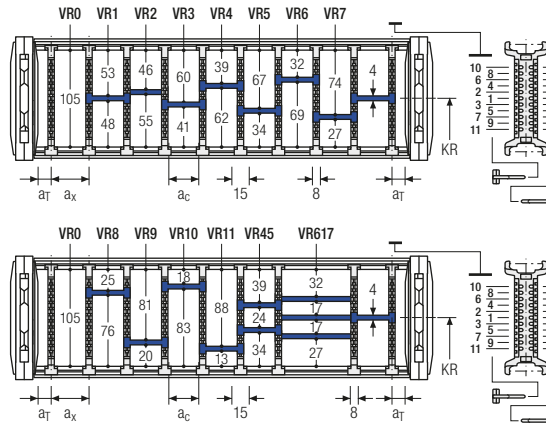

Aluminum partitions in 1 mm increments with a_x > 42 mm are also available.

a _x (center distance of dividers) [mm]											
a _c (nominal width of inner chamber) [mm]											
16	18	23	28	32	33	38	43	48	58	64	68
8	10	15	20	24	25	30	35	40	50	56	60
78	80	88	96	112	128	144	160	176	192	208	
70	72	80	88	104	120	136	152	168	184	200	

When using plastic partitions with a_x > 112 mm, we recommend an additional center support with a twin divider (S_T = 5 mm). Twin dividers are also suitable for retrofitting in the partition system.

Order example

TS3

A

3

K1

34

VR1

K4

38

VR3

Divider system
Version
n_T
Chamber
a_x
Height separation

Please state the designation of the divider system (**TS0, TS3**), the version, and the number of dividers per cross section [n_T]. In addition, please also enter the chambers [K] from left to right, as well as the assembly distances [a_T/a_x].

Increments



tsubaki-kabelschlepp.com/xlt

XLT1650 | End connectors

End connectors – steel

End connectors made of steel. The connection variants on the fixed point and on the driver can be combined and changed later on, if necessary.

Key for abbreviations
on page 16

Design guidelines
from page 62

Technical support:
technik@kabelschlepp.de

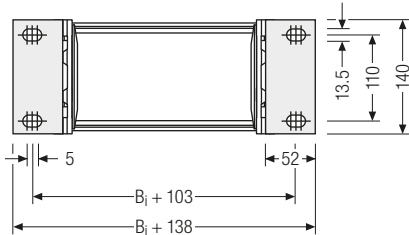
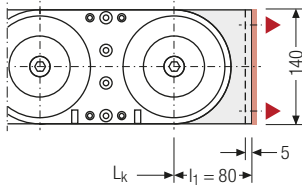
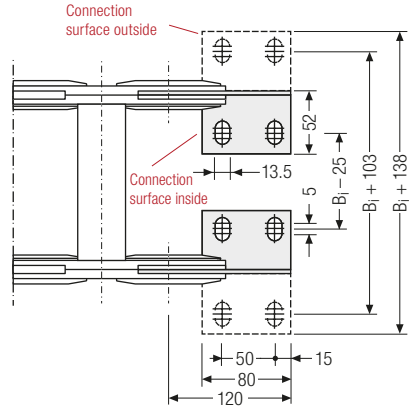
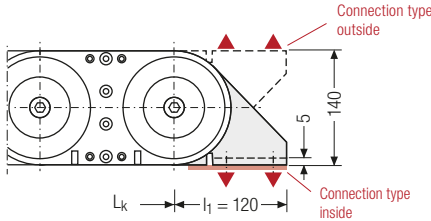

▲ Assembly options

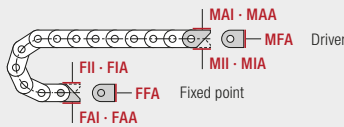

Connection point **Connection surface**
F – fixed point **I** – connection surface inside
M – driver **A** – connection surface outside

Connection type
A – threaded joint outside (standard)
I – threaded joint inside
F – flange connection

Order example

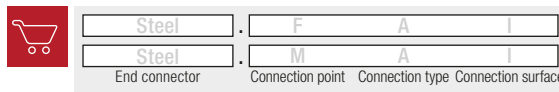

 We recommend the use of strain reliefs before driver and fixed point. See from p. 794.



Subject to change.

XLT series

Inner heights



Inner widths



Increments



tsubaki-kabelschlepp.com/xlt