

# S/SX Tubes series

Extremely robust and sturdy covered steel cable carriers



Trademarks are legally protected for the TSUBAKI KABELSCHLEPP GmbH as a national or international registration in the following countries: [tsubaki-kabelschlepp.com/trademarks](http://tsubaki-kabelschlepp.com/trademarks)

Subject to change without notice.

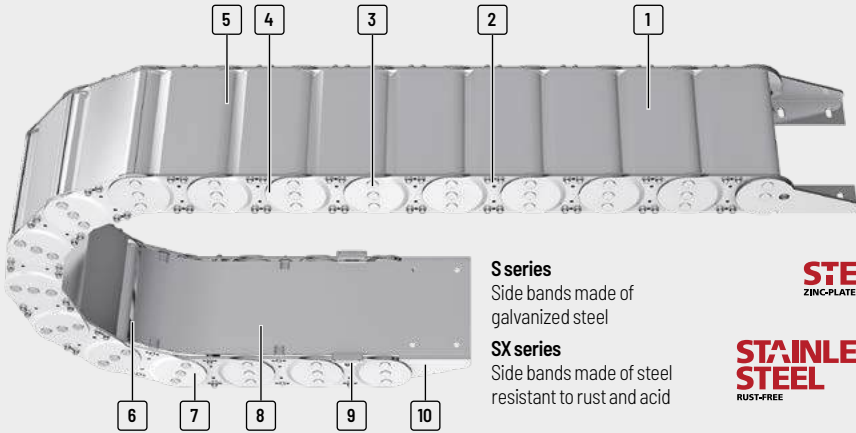

**STEEL**  
ZINC-PLATED

**STAINLESS STEEL**  
RUST-FREE

#### S series

Side bands made of galvanized steel

#### SX series

Side bands made of steel resistant to rust and acid

- 1 Aluminum covers available in **1 mm width sections**
- 2 4 bolted aluminum covers for extreme loads
- 3 Joint design with hardened bolts for long service life
- 4 Cranked link plate design
- 5 Can be opened on the inside and the outside for cable laying
- 6 Different separation options for the cables
- 7 Extremely robust side bands, galvanized or stainless steel
- 8 Steel band cover available in **1 mm width sections**
- 9 Replaceable glide shoes
- 10 End connectors for different connection variants

## Features

- » Extremely robust, sturdy steel cable carriers for heavy mechanical loads and rough environmental conditions
- » Side bands made of galvanized steel (S series) or corrosion-resistant and acid-resistant steel (SX series) in three qualities: ER 1 / ER 1S and ER 2
- » Very sturdy link plates, each consisting of two individual plates
- » Very extensive unsupported lengths even with large additional loads
- » Joint design with multi stroke system and hardened bolt
- » Bolted stay systems, solid end connectors
- » Explosion protection with classification EX II 2 GD as per ATEX RL

### The design

Proven steel cable carriers with extremely sturdy link plates and dedicated joint design with multi stroke system and hardened bolt. The extremely sturdy design allows extensive unsupported lengths and high possible additional loads.

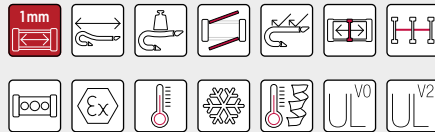

**Sandwich design:**  
Link plates consist of two plates



**Glide shoes available for gliding applications**



**Stroke system with hardened bolt and circlips**



**Also available as open variants with different stay variants, p. 718**

Type	Opening variant	Stay variant	$h_i$ [mm]	$h_G$ [mm]	$B_i$ [mm]	$B_k$ [mm]	$B_i$ - grid [mm]	t [mm]	KR [mm]	Additional load $\leq$ [kg/m]	Cable- $d_{max}$ [mm]

## S/SX0650 Tubes



RMD

30

50

65 - 465

100 - 500

1

65

115 - 400

30

24

## S/SX0950 Tubes



RMD

44

68

88 - 563

125 - 600

1

95

170 - 600

45

35

## S/SX1250 Tubes



RMD

69

94

101 - 751

150 - 800

1

125

200 - 1000

50

55

## S/SX1800 Tubes



RMD

104

140

188 - 938

250 - 1000

1

180

320 - 1300

60

83

\* Depending on the specific application, additional gliding elements or rollers are required.

\*\* Application-specific, values on request.

Unsupported arrangement			Gliding arrangement			Inner Distribution				Movement			Page
Travel length ≤ [m]	$v_{max} \leq [m/s]$	$a_{max} \leq [m/s^2]$	Travel length ≤ [m]	$v_{max} \leq [m/s]$	$a_{max} \leq [m/s^2]$	TS0	TS1	TS2	TS3	vertical hanging or standing	lying on the side	rotating arrangement	

5.8	2.5	5	**	1	2	•	•	-	-	•	•	-	782
-----	-----	---	----	---	---	---	---	---	---	---	---	---	-----

8.8	2.5	5	**	1	2	•	•	-	-	•	•	-	788
-----	-----	---	----	---	---	---	---	---	---	---	---	---	-----

13.5	2.5	5	**	1	2	•	•	•	-	•	•	-	794
------	-----	---	----	---	---	---	---	---	---	---	---	---	-----

17.8	2	3	**	0.8	2	•	•	-	•	•	•	-	798
------	---	---	----	-----	---	---	---	---	---	---	---	---	-----

MT series

XLT series

ROBOTRAX® System

FLATVEVOR®

CLEANVEVOR®

LS/LSX series

S/SX series

S/SX-Tubes series

Accessories

TRAXLINE®

# S/SX0650



**Pitch**  
65 mm



**Inner height**  
30 mm



**Chain widths**  
100 – 500 mm



**Bending radii**  
115 – 300 mm

## Stay variants



**Aluminum stay RMD** ..... page **782**

### Aluminum cover system

- » Bolted aluminum covers for maximum stability.
- » For applications generating chips or coarse contamination.
- » **Inside/outside:** Threaded joint easy to release.



### TOTALTRAX® complete systems

Benefit from the advantages of the TOTALTRAX® complete system. A complete delivery from one source – with a warranty certificate on request! Learn more at [tsubaki-kabelschlepp.com/totaltrax](http://tsubaki-kabelschlepp.com/totaltrax)



### TRAXLINE® cables for cable carriers

Hi-flex electric cables which were especially developed, optimized and tested for use in cable carriers can be found at [tsubaki-kabelschlepp.com/traxline](http://tsubaki-kabelschlepp.com/traxline)

Unsupported arrangement

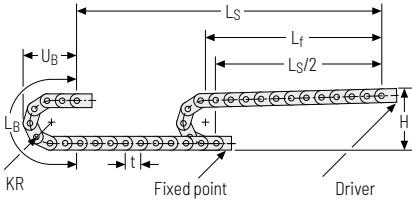

Installation height  $H_2$

$H_2 = H + 10 \text{ mm/m}$

**Load diagram for unsupported length** depending on the additional load.

Intrinsic cable carrier weight  $q_k = 4.5 \text{ kg/m}$ . For other inner widths, the maximum additional load changes.

For cable carriers with a aluminum cover system, a higher intrinsic cable carrier weight is to note.

KR [mm]	H [mm]	LB [mm]	UB [mm]
115	305	621	270
125	325	653	280
135	345	684	290
145	365	716	300
155	385	747	310
175	425	810	330
200	475	888	355
250	575	1045	405
300	675	1202	455
400	875	1516	555

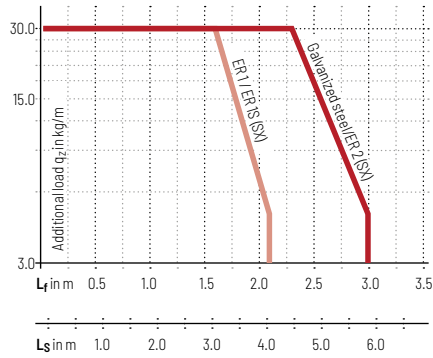

**Speed**  
up to 2.5 m/s

**Acceleration**  
up to 5 m/s<sup>2</sup>

**Travel length**  
up to 5.8 m

**Additional load**  
up to 30 kg/m

Gliding arrangement

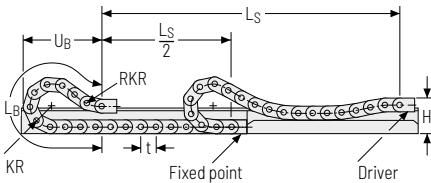

**Speed**  
up to 1 m/s

**Acceleration**  
up to 2 m/s<sup>2</sup>

**Travel length**  
on request

**Additional load**  
up to 30 kg/m

The gliding cable carrier must be guided in a channel. See p. 844.

Glide shoes have to be used for gliding applications.

MT series
XLT series
ROBOTRAX® System
FLATVEYOR®
CLEANVEYOR®
LS/LSX series
S/SX series
S/SX-Tubes series
Accessories
TRAXLINE®

## Aluminum stay RMD – aluminum cover system

- » Bolted aluminum covers for maximum stability.
- » For applications generating chips or coarse contamination.
- » Available customized in **1 mm grid**.
- » **Inside/outside:** Threaded joint easy to release.



Stay arrangement on each chain link (**VS: fully-stayed**)



**1 mm** B<sub>k</sub> 100 – 500 mm  
in 1 mm width sections

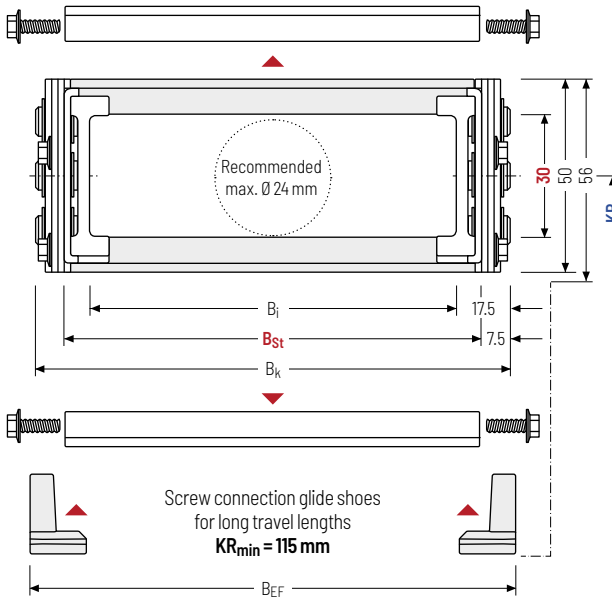

The maximum cable diameter strongly depends on the bending radius and the desired cable type. Please contact us.

### Calculating the cable carrier length

#### Cable carrier length L<sub>k</sub>

$$L_k \approx \frac{L_S}{2} + L_B$$

Cable carrier length L<sub>k</sub>  
rounded to pitch t

h <sub>i</sub> [mm]	h <sub>g</sub> [mm]	h <sub>g'</sub> [mm]	B <sub>i</sub> [mm]	B <sub>St</sub> [mm]*	B <sub>k</sub> [mm]	B <sub>EF</sub> [mm]	KR [mm]					q <sub>k</sub> [kg/m]
30	50	56	65	85	B <sub>St</sub> + 15	B <sub>St</sub> + 20	115	125	135	145	155	4.84
			465	485			175	200	250	300	400	10.50

\* in 1 mm width sections

### Order example



**SX0650**

Type

**180**

B<sub>St</sub> [mm]

**RMD**

Stay variant

**135**

KR [mm]

**St**

Material

**1430**

L<sub>k</sub> [mm]

**VS**

Stay arrangement

### Divider systems

As a standard, the divider system is mounted on every 2<sup>nd</sup> cover/chain link (HS).

As a standard, dividers or the complete divider system (dividers with height separations) are movable in the cross section (**version A**).

### Divider system TSO without height separation

Vers.	a <sub>T</sub> min [mm]	a <sub>x</sub> min [mm]	a <sub>c</sub> min [mm]	n <sub>T</sub> min
A	11.5	13	10	-

The dividers can be moved in the cross section.

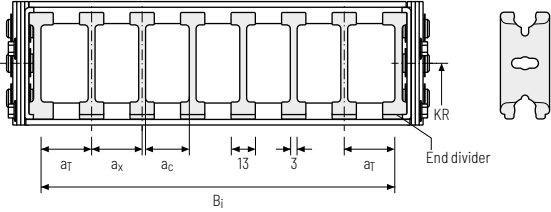

### Divider system TS1 with continuous height separation

Vers.	a <sub>T</sub> min [mm]	a <sub>x</sub> min [mm]	a <sub>c</sub> min [mm]	n <sub>T</sub> min
A	11.5	13	10	2

The dividers can be moved in the cross section.

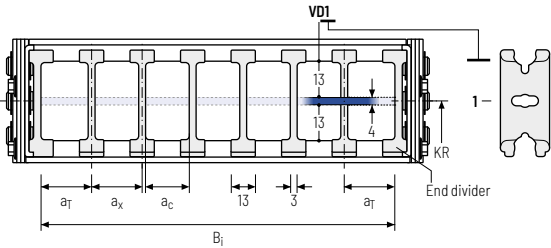

### Order example

TS1

A

3

VD0

⋮

VD1

Divider system
Version
n<sub>T</sub>
Height separation

Please state the designation of the divider system (**TS0, TS1...**), version and number of dividers per cross section [n<sub>T</sub>].

If using divider systems with height separation (**TS1**) please also state the positions [e.g. VD1] viewed from the left driver belt. You are welcome to add a sketch to your order.

The end dividers are part of the divider system and don't have to be ordered separately.

	MT series
	XLT series
	ROBOTRAX® System
	FLATVEVOR®
	CLEANVEVOR®
	LS/LSX series
	S/SX series
	S/SX-Tubes series
	Accessories
	TRAXLINE®



## End connectors - steel

End connectors made of steel. The connection variants on the fixed point and on the driver can be combined and changed later on, if necessary.

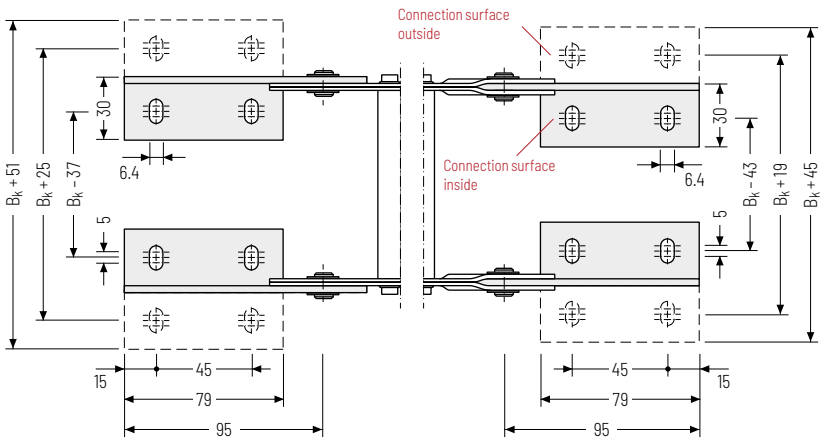
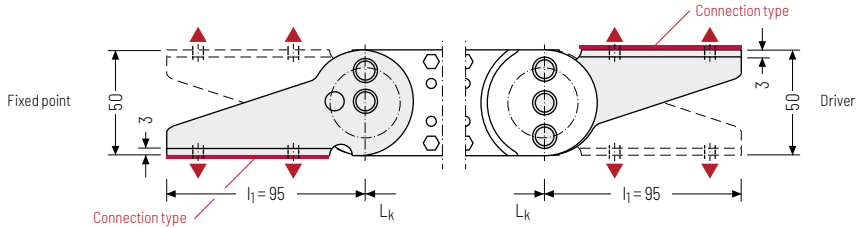

### ▲ Assembly options

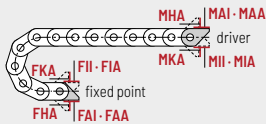

### Connection point

**F** - fixed point  
**M** - driver

### Connection type

**A** - threaded joint to outside (standard)  
**I** - threaded joint to inside  
**H** - threaded joint, rotated 90° to the outside  
**K** - threaded joint, rotated 90° to the inside

### Connection surface

**A** - connection surface inside (standard)  
**I** - connection surface outside

**Caution:** The standard connection variant FAI/MAI is only possible from B<sub>k</sub> of 70 mm.

## Order example



Steel	F	A	I
Steel	M	A	I
End connector	Connection point	Connection type	Connection surface



We recommend the use of strain reliefs at the driver and fixed point. See from p. 904.

MT  
seriesXLT  
seriesROBOTRAX®  
System

FLATVEYOR®

CLEANVEYOR®

LS/LSX  
seriesS/SX  
seriesS/SX-Tubes  
series

Accessories

TRAXLINE®

# S/SX0950



**Pitch**  
95 mm



**Inner height**  
44 mm



**Chain widths**  
125 - 600 mm



**Bending radii**  
170 - 600 mm

## Stay variants



**Aluminum stay RMD** ..... page **788**

### Aluminum cover system

- » Bolted aluminum covers for maximum stability.
- » For applications generating chips or coarse contamination.
- » **Inside/outside:** Threaded joint easy to release.



### TOTALTRAX® complete systems

Benefit from the advantages of the TOTALTRAX® complete system. A complete delivery from one source – with a warranty certificate on request! Learn more at [tsubaki-kabelschlepp.com/totaltrax](http://tsubaki-kabelschlepp.com/totaltrax)



### TRAXLINE® cables for cable carriers

Hi-flex electric cables which were especially developed, optimized and tested for use in cable carriers can be found at [tsubaki-kabelschlepp.com/traxline](http://tsubaki-kabelschlepp.com/traxline)

**Unsupported arrangement**

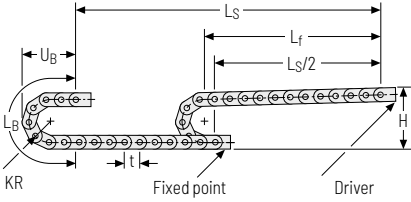

KR [mm]	H [mm]	L <sub>B</sub> [mm]	U <sub>B</sub> [mm]
170	442	914	395
200	502	1008	425
260	622	1197	485
290	682	1291	515
320	742	1385	545
350	802	1480	575
410	922	1668	635
600	1302	2264	825

Installation height H<sub>z</sub>

$H_z = H + 10 \text{ mm/m}$

**Load diagram for unsupported length** depending on the additional load.

Intrinsic cable carrier weight  $q_k = 7.6 \text{ kg/m}$ . For other inner widths, the maximum additional load changes.

For cable carriers with a aluminum cover system, a higher intrinsic cable carrier weight is to note.

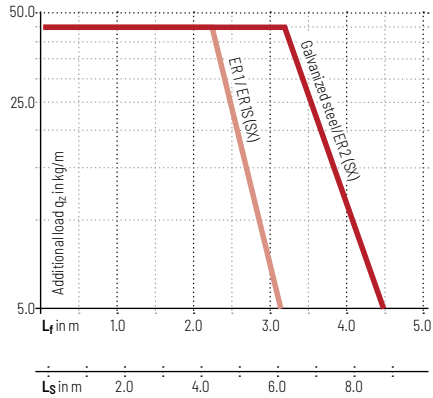

- Speed**  
up to 2.5 m/s
- Acceleration**  
up to 5 m/s<sup>2</sup>
- Travel length**  
up to 8.8 m
- Additional load**  
up to 45 kg/m

**Gliding arrangement**

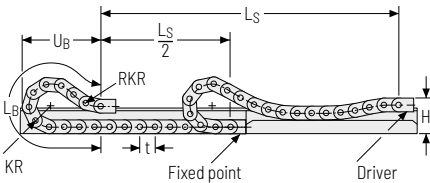

- Speed**  
up to 1 m/s
- Acceleration**  
up to 2 m/s<sup>2</sup>
- Travel length**  
on request
- Additional load**  
up to 45 kg/m

The gliding cable carrier must be guided in a channel. See p. 844.

Glide shoes have to be used for gliding applications.

MT series
XLT series
ROBOTRAX® System
FLATVEYOR®
CLEANVEYOR®
LS/LSX series
S/SX series
S/SX-Tubes series
Accessories
TRAXLINE®

## Aluminum stay RMD – aluminum cover system

- » Bolted aluminum covers for maximum stability.
- » For applications generating chips or coarse contamination.
- » Available customized in **1 mm grid**.
- » **Inside/outside:** Threaded joint easy to release.



Stay arrangement on each chain link (**VS: fully-stayed**)



**1 mm** B<sub>k</sub> 125 – 600 mm  
in 1 mm width sections

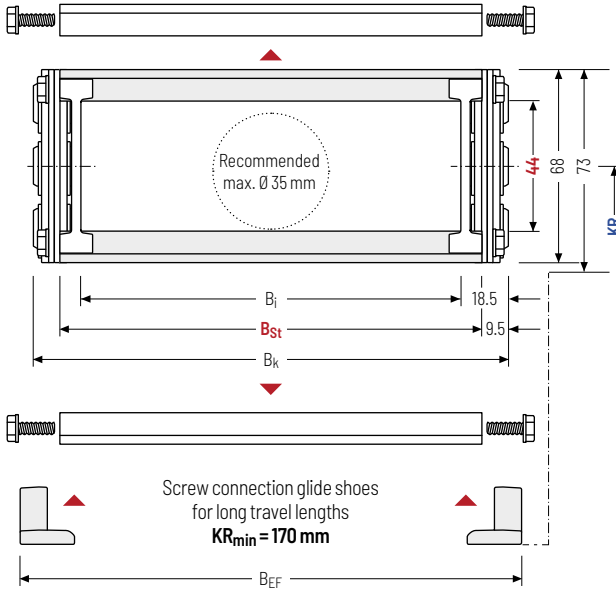

The maximum cable diameter strongly depends on the bending radius and the desired cable type. Please contact us.

### Calculating the cable carrier length

#### Cable carrier length L<sub>k</sub>

$$L_k \approx \frac{L_S}{2} + L_B$$

Cable carrier length L<sub>k</sub>  
rounded to pitch t

h <sub>i</sub> [mm]	h <sub>G</sub> [mm]	h <sub>G'</sub> [mm]	B <sub>i</sub> [mm]	B <sub>St</sub> [mm]*	B <sub>k</sub> [mm]	B <sub>EF</sub> [mm]	KR [mm]				q <sub>k</sub> [kg/m]
44	68	73	88	106	B <sub>St</sub> + 19	B <sub>St</sub> + 28	170	200	260	290	9.97
			563	581			320	350	410	600	21.95

\* in 1 mm width sections

### Order example



SX0950

Type

107

B<sub>St</sub>[mm]

RMD

Stay variant

200

KR[mm]

St

Material

2375

L<sub>k</sub>[mm]

VS

Stay arrangement

**Divider systems**

As a standard, the divider system is mounted on every 2<sup>nd</sup> cover/chain link (HS).

As a standard, dividers or the complete divider system (dividers with height separations) are movable in the cross section (**version A**).

**Divider system TSO without height separation**

Vers.	a <sub>T</sub> min [mm]	a <sub>x</sub> min [mm]	a <sub>c</sub> min [mm]	n <sub>T</sub> min
A	12	14	10	-

The dividers can be moved in the cross section.

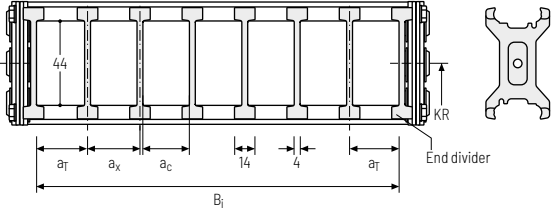

**Divider system TS1 with continuous height separation**

Vers.	a <sub>T</sub> min [mm]	a <sub>x</sub> min [mm]	a <sub>c</sub> min [mm]	n <sub>T</sub> min
A	12	14	10	2

The dividers can be moved in the cross section.

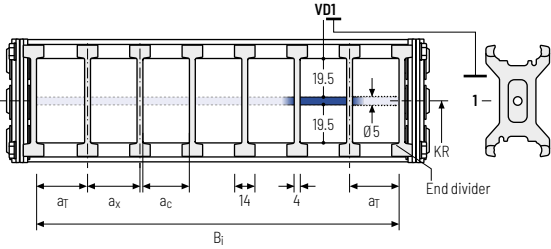

**Order example**

TS1

A

3

VD0

⋮

VD1

Divider system

Version

n<sub>T</sub>

Height separation

Please state the designation of the divider system (**TS0, TS1...**), version and number of dividers per cross section [n<sub>T</sub>].

If using divider systems with height separation (**TS1**) please also state the positions [e.g. VD1] viewed from the left driver belt. You are welcome to add a sketch to your order.

The end dividers are part of the divider system and don't have to be ordered separately.

Subject to change without notice.

	MT series
	XLT series
	ROBOTRAX® System
	FLATVEVOR®
	CLEANVEVOR®
	LS/LSX series
	S/SX series
	S/SX-Tubes series
	Accessories
	TRAXLINE®







TRAXLINE®

Accessories

S/SX-Tubes  
series

S/SX  
series

LS/LSX  
series

CLEANVEYOR®

FLATVEYOR®

ROBOTRAX®  
System

XLT  
series

MT  
series



# S/SX1250



**Pitch**  
125 mm



**Inner height**  
69 mm



**Chain widths**  
150 – 800 mm



**Bending radii**  
200 – 1000 mm

## Stay variants



**Aluminum stay RMD** ..... page **794**

### Aluminum cover system

- » Bolted aluminum covers for maximum stability.
- » For applications generating chips or coarse contamination.
- » **Inside/outside:** Threaded joint easy to release.



### TOTALTRAX® complete systems

Benefit from the advantages of the TOTALTRAX® complete system. A complete delivery from one source – with a warranty certificate on request! Learn more at [tsubaki-kabelschlepp.com/totaltrax](http://tsubaki-kabelschlepp.com/totaltrax)



### TRAXLINE® cables for cable carriers

Hi-flex electric cables which were especially developed, optimized and tested for use in cable carriers can be found at [tsubaki-kabelschlepp.com/traxline](http://tsubaki-kabelschlepp.com/traxline)

Unsupported arrangement

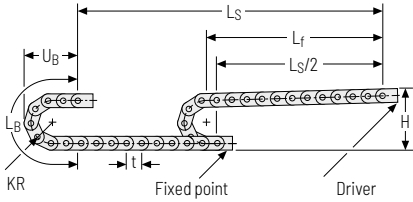

Installation height  $H_z$

$H_z = H + 10 \text{ mm/m}$

Load diagram for unsupported length depending on the additional load.

Intrinsic cable carrier weight  $q_k = 13 \text{ kg/m}$ . For other inner widths, the maximum additional load changes.

For cable carriers with an aluminum cover system, a higher intrinsic cable carrier weight is to note.

KR [mm]	H [mm]	L <sub>B</sub> [mm]	U <sub>B</sub> [mm]
200	541	1128	497
220	581	1191	517
260	661	1317	557
300	741	1442	597
340	821	1568	637
380	901	1694	677
420	981	1820	717
460	1061	1945	757
500	1141	2071	797
540	1221	2196	837
600	1341	2385	897
1000	2141	3640	1297

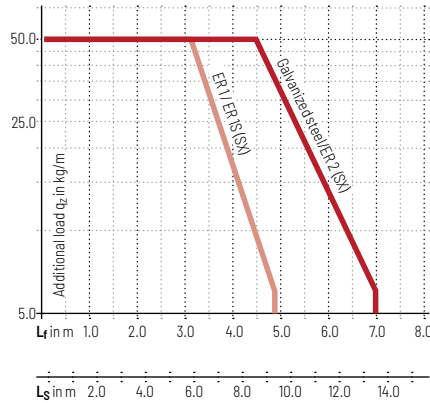

**Speed**  
up to 2.5 m/s

**Acceleration**  
up to 5 m/s<sup>2</sup>

**Travel length**  
up to 13.5 m

**Additional load**  
up to 50 kg/m

Gliding arrangement

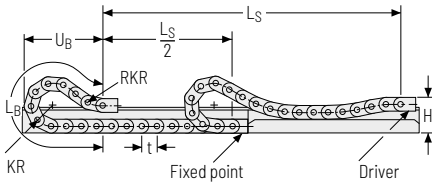

The gliding cable carrier must be guided in a channel. See p. 844.

Glide shoes have to be used for gliding applications.

**Speed**  
up to 1 m/s

**Acceleration**  
up to 2 m/s<sup>2</sup>

**Travel length**  
on request

**Additional load**  
up to 50 kg/m

MT series
XLT series
ROBOTRAX® System
FLATVEYOR®
CLEANVEYOR®
LS/LSX series
S/SX series
S/SX-tubes series
Accessories
TRAXLINE®

## Aluminum stay RMD – aluminum cover system

- » Bolted aluminum covers for maximum stability.
- » For applications generating chips or coarse contamination.
- » Available customized in **1 mm grid**.
- » **Inside/outside:** Threaded joint easy to release.



Stay arrangement on each chain link (**VS: fully-stayed**)



**1 mm** B<sub>k</sub> 150 – 800 mm  
in 1 mm width sections

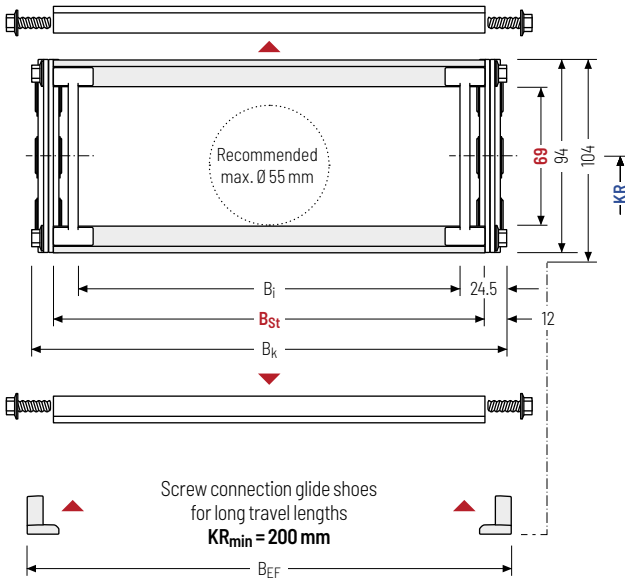

The maximum cable diameter strongly depends on the bending radius and the desired cable type. Please contact us.

### Calculating the cable carrier length

#### Cable carrier length L<sub>k</sub>

$$L_k \approx \frac{L_S}{2} + L_B$$

Cable carrier length L<sub>k</sub>  
rounded to pitch t

h <sub>i</sub> [mm]	h <sub>G</sub> [mm]	h <sub>G'</sub> [mm]	B <sub>i</sub> [mm]	B <sub>St</sub> [mm]*	B <sub>k</sub> [mm]	B <sub>EF</sub> [mm]	KR [mm]						q <sub>k</sub> [kg/m]
69	94	104	101 75	126 776	B <sub>St</sub> + 24	B <sub>St</sub> + 30	200**	220**	260	300	340	380	15.48
							420	460	500	540	600	1000	32.38

\* in 1 mm width sections \*\* geometrically reduced inner height

### Order example



S1250

Type

352

B<sub>St</sub>[mm]

RMD

Stay variant

260

KR [mm]

St

Material

4750

L<sub>k</sub>[mm]

VS

Stay arrangement

**Divider systems**

As a standard, the divider system is mounted on every 2<sup>nd</sup> cover/chain link (HS).

As a standard, dividers or the complete divider system (dividers with height separations) are movable in the cross section (**version A**).

**Divider system TS0 without height separation**

Vers.	a <sub>T</sub> min [mm]	a <sub>x</sub> min [mm]	a <sub>c</sub> min [mm]	n <sub>T</sub> min
A	17.5	20	15	-

The dividers can be moved in the cross section.

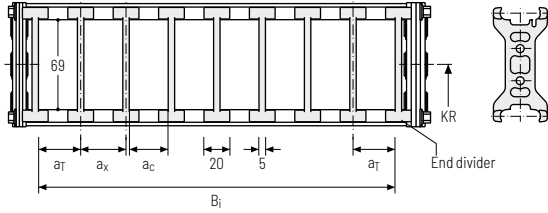

**Divider system TS1 with continuous height separation**

Vers.	a <sub>T</sub> min [mm]	a <sub>x</sub> min [mm]	a <sub>c</sub> min [mm]	n <sub>T</sub> min
A	10	12	8	2

The dividers can be moved in the cross section.

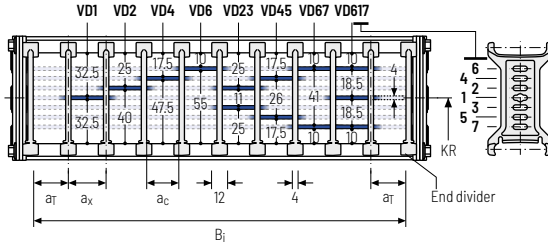

**Divider system TS2 with partial height separation**

Vers.	a <sub>T</sub> min [mm]	a <sub>x</sub> min [mm]	a <sub>c</sub> min [mm]	n <sub>T</sub> min
A	11*/17**	14*/21	8*/15	2

\* For VR0      \*\* For version with height separation to the end divider

With grid distribution (1 mm grid). The dividers are attached by the height separation, the grid can be moved in the cross section.

Sliding dividers are optionally available (thickness of divider = 4 mm).

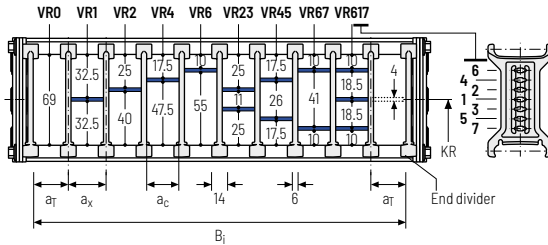

**Order example**

TS2

A

3

K1

34

VR1

⋮  
 ⋮  
 ⋮

K4

38

VR3

Divider system    Version    n<sub>T</sub>    Chamber    a<sub>x</sub>    Height separation

	MT series
	XLT series
	ROBOTRAX® System
	FLATVEVOR®
	CLEANVEVOR®
	LS/LSX series
	S/SX series
	S/SX-Tubes series
Accessories	
	TRAXLINE®

## End connectors - steel

End connectors made of steel. The connection variants on the fixed point and on the driver can be combined and changed later on, if necessary.

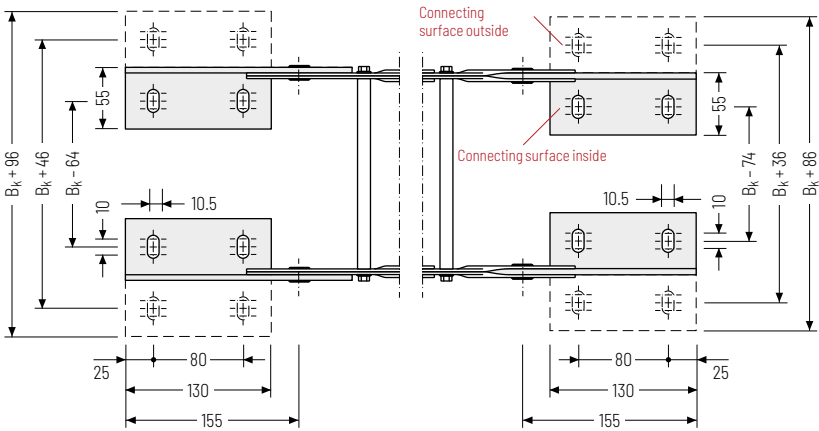
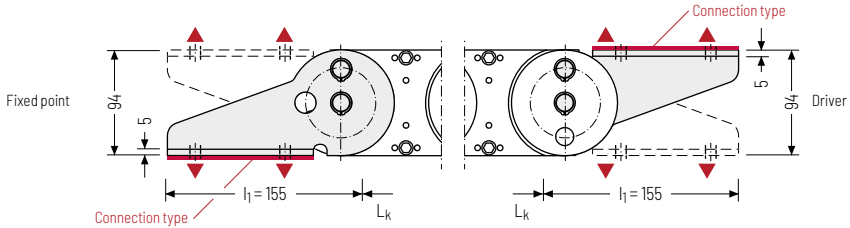

### ▲ Assembly options

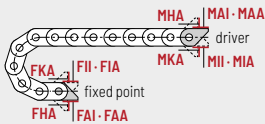

#### Connection point

**F** - fixed point  
**M** - driver

#### Connection type

**A** - threaded joint to outside (standard)  
**I** - threaded joint to inside  
**H** - threaded joint, rotated 90° to the outside  
**K** - threaded joint, rotated 90° to the inside

#### Connection surface

**A** - connection surface inside (standard)  
**I** - connection surface outside



**Caution:** The standard connection variant FAI/MAI is only possible from  $B_k$  of 125 mm.

### Order example



Steel	F	A	I
Steel	M	A	I
End connector	Connection point	Connection type	Connection surface



We recommend the use of strain reliefs at the driver and fixed point. See from p. 904.



Subject to change without notice.

797

MT  
series

XLT  
series

ROBOTRAX®  
System

FLATVEYOR®

CLEANVEYOR®

LS/LSX  
series

S/SX  
series

S/SX-Tubes  
series

Accessories

TRAXLINE®

# S/SX1800



**Pitch**  
180 mm



**Inner height**  
104 mm



**Chain widths**  
250 - 1000 mm



**Bending radii**  
320 - 1300 mm

## Stay variants



**Aluminum stay RMD** ..... page 800

### Aluminum cover system

- » Bolted aluminum covers for maximum stability.
- » For applications generating chips or coarse contamination.
- » **Inside/outside:** Threaded joint easy to release.



### TOTALTRAX® complete systems

Benefit from the advantages of the TOTALTRAX® complete system.  
A complete delivery from one source - with a warranty certificate on request!  
Learn more at [tsubaki-kabelschlepp.com/totaltrax](http://tsubaki-kabelschlepp.com/totaltrax)



### TRAXLINE® cables for cable carriers

Hi-flex electric cables which were especially developed,  
optimized and tested for use in cable carriers can be  
found at [tsubaki-kabelschlepp.com/traxline](http://tsubaki-kabelschlepp.com/traxline)



### Unsupported arrangement

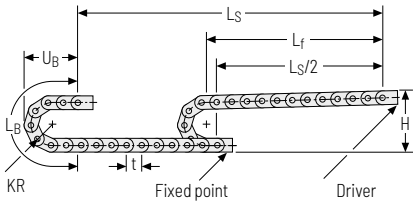

Installation height  $H_2$

$$H_2 = H + 10 \text{ mm/m}$$

**Load diagram for unsupported length** depending on the additional load.

Intrinsic cable carrier weight  $q_k = 26 \text{ kg/m}$ . For other inner widths, the maximum additional load changes.

For cable carriers with a aluminum cover system, a higher intrinsic cable carrier weight is to note.

KR [mm]	H [mm]	LB [mm]	UB [mm]
320	850	1725	750
375	960	1898	805
435	1080	2087	865
490	1190	2259	920
605	1420	2620	1035
720	1650	2982	1150
890	1990	3516	1320
1175	2560	4411	1605
1300	2810	4804	1730

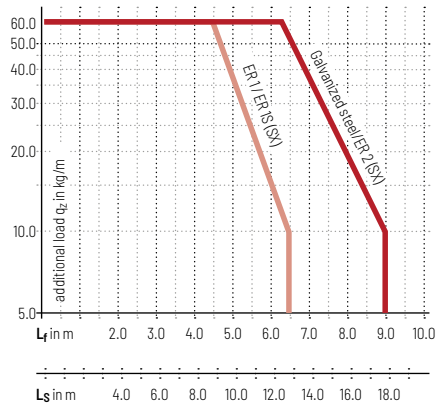

**Speed**  
up to 2 m/s

**Acceleration**  
up to 3 m/s<sup>2</sup>

**Travel length**  
up to 17.8 m

**Additional load**  
up to 60 kg/m

### Gliding arrangement

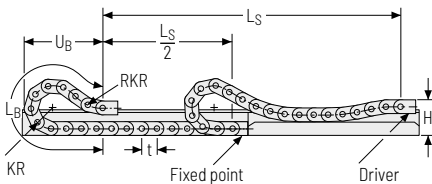

The gliding cable carrier must be guided in a channel. See p. 844.

Glide shoes have to be used for gliding applications.

**Speed**  
up to 0.8 m/s

**Acceleration**  
up to 2 m/s<sup>2</sup>

**Travel length**  
on request

**Additional load**  
up to 60 kg/m



## Aluminum stay RMD – aluminum cover system

- » Bolted aluminum covers for maximum stability.
- » For applications generating chips or coarse contamination.
- » Available customized in **1 mm grid**.
- » **Inside/outside:** Threaded joint easy to release.



Stay arrangement on each chain link (**VS: fully-stayed**)



**1 mm** B<sub>k</sub> 250 – 1000 mm  
in 1 mm width sections

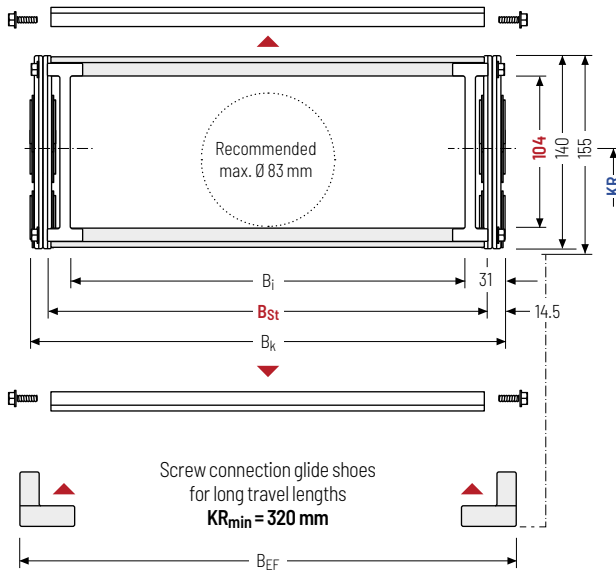

The maximum cable diameter strongly depends on the bending radius and the desired cable type. Please contact us.

### Calculating the cable carrier length

#### Cable carrier length L<sub>k</sub>

$$L_k \approx \frac{L_S}{2} + L_B$$

Cable carrier length L<sub>k</sub>  
rounded to pitch t

h <sub>i</sub> [mm]	h <sub>G</sub> [mm]	h <sub>G'</sub> [mm]	B <sub>i</sub> [mm]	B <sub>St</sub> [mm]*	B <sub>k</sub> [mm]	B <sub>EF</sub> [mm]	KR [mm]			q <sub>k</sub> [kg/m]	
104	140	155	188	221	B <sub>St</sub> + 29	B <sub>St</sub> + 40	320	375	435	490	28.46
			938	971			720	890	1175	1300	47.67

\* in 1 mm width sections

### Order example



**S1800**

Type

**417**

B<sub>St</sub> [mm]

**RMD**

Stay variant

**375**

KR [mm]

**St**

Material

**5940**

L<sub>k</sub> [mm]

**VS**

Stay arrangement

**Divider systems**

As a standard, the divider system is mounted on every 2<sup>nd</sup> cover/chain link (HS).

As a standard, dividers or the complete divider system (dividers with height separations) are movable in the cross section (**version A**).

**Divider system TS0 without height separation**

Vers.	a <sub>T</sub> min [mm]	a <sub>x</sub> min [mm]	a <sub>c</sub> min [mm]	π <sub>T</sub> min
A	21.5	25	17.5	-

The dividers can be moved in the cross section.

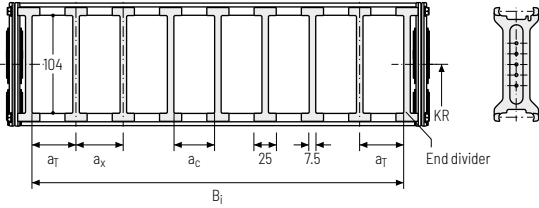

**Divider system TS1 with continuous height separation**

Vers.	a <sub>T</sub> min [mm]	a <sub>x</sub> min [mm]	a <sub>c</sub> min [mm]	π <sub>T</sub> min
A	21.5	25	17.5	2

The dividers can be moved in the cross section.

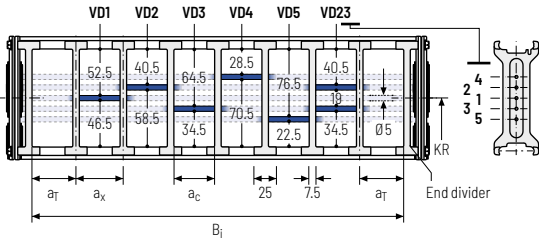

**Divider system TS3 with height separation consisting of plastic partitions**

Vers.	a <sub>T</sub> min [mm]	a <sub>x</sub> min [mm]	a <sub>c</sub> min [mm]	π <sub>T</sub> min
A	38*/16.5**/12***	16/42*	8	2

\* For aluminum partitions  
 \*\* For VRO  
 \*\*\* For version with height separation to the end divider

The dividers are fixed with the partitions. The entire divider system can be moved in the cross section.

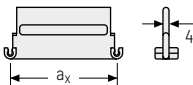
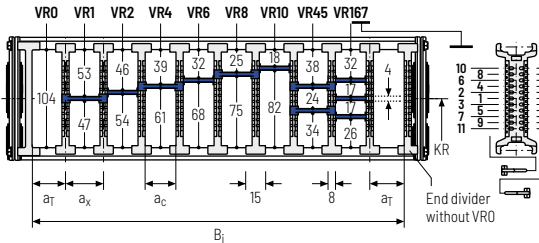

Aluminum partitions in 1 mm increments with a<sub>x</sub> > 42 mm are also available.

a <sub>x</sub> (center distance of dividers) [mm]											
a <sub>c</sub> (nominal width of inner chamber) [mm]											
16	18	23	28	32	33	38	43	48	58	64	68
8	10	15	20	24	25	30	35	40	50	56	60
78	80	88	96	112	128	144	160	176	192	208	
70	72	80	88	104	120	136	152	168	184	200	

When using plastic partitions with a<sub>x</sub> > 112 mm, we recommend an additional center support with a twin divider (S<sub>T</sub> = 5 mm). Twin dividers are also suitable for retrofitting in the partition system.

## End connectors - steel

End connectors made of steel. The connection variants on the fixed point and on the driver can be combined and changed later on, if necessary.

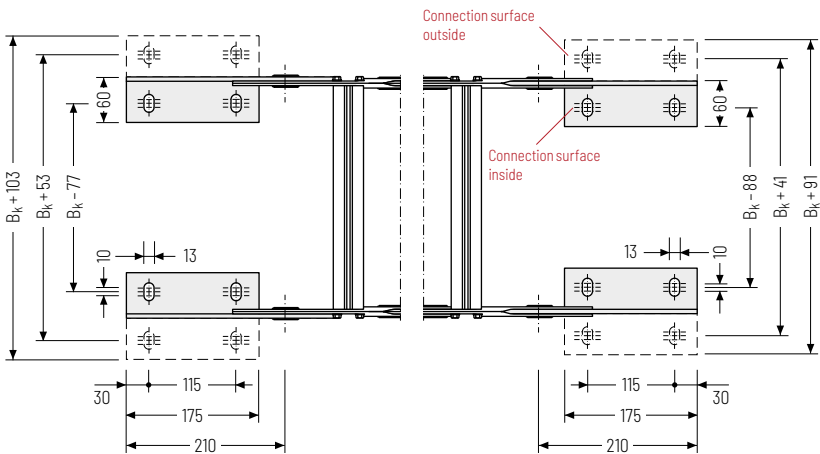
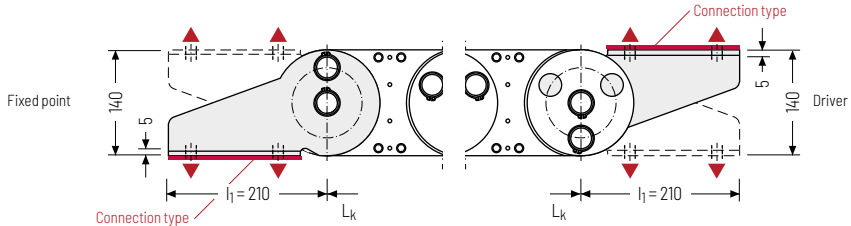

### ▲ Assembly options

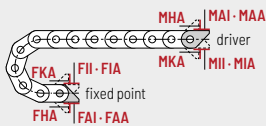

#### Connection point

**F** - fixed point  
**M** - driver

#### Connection type

**A** - threaded joint to outside (standard)  
**I** - threaded joint to inside  
**H** - threaded joint, rotated 90° to the outside  
**K** - threaded joint, rotated 90° to the inside

#### Connection surface

**A** - connection surface inside (standard)  
**I** - connection surface outside

**Caution:** The standard connection variant FAI/MAI is only possible from  $B_k$  of 139 mm.

### Order example



Steel	F	A	I
Steel	M	A	I
End connector	Connection point	Connection type	Connection surface



We recommend the use of strain reliefs at the driver and fixed point. See from p. 904.



Subject to change without notice.

803

MT  
series

XLT  
series

ROBOTRAX®  
System

FLATVEYOR®

CLEANVEYOR®

LS/LSX  
series

S/SX  
series

S/SX-Tubes  
series

Accessories

TRAXLINE®