

K series

**Cost-effective, robust cable carrier –
suitable for large additional loads**

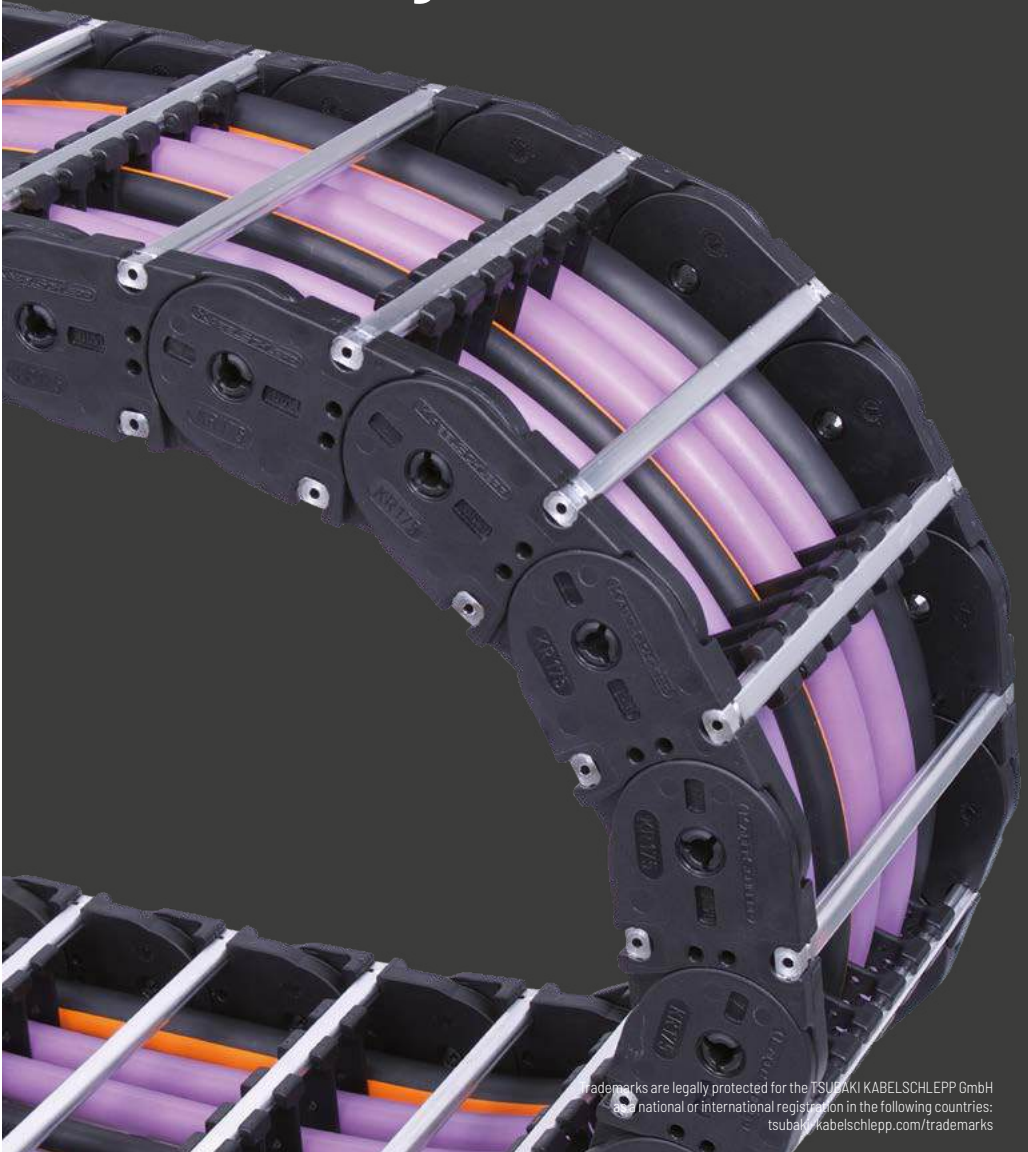

Trademarks are legally protected for the TSUBAKI KABELSCHLEPP GmbH
national or international registration in the following countries:
tsubaki-kabelschlepp.com/trademarks

Subject to change without notice.

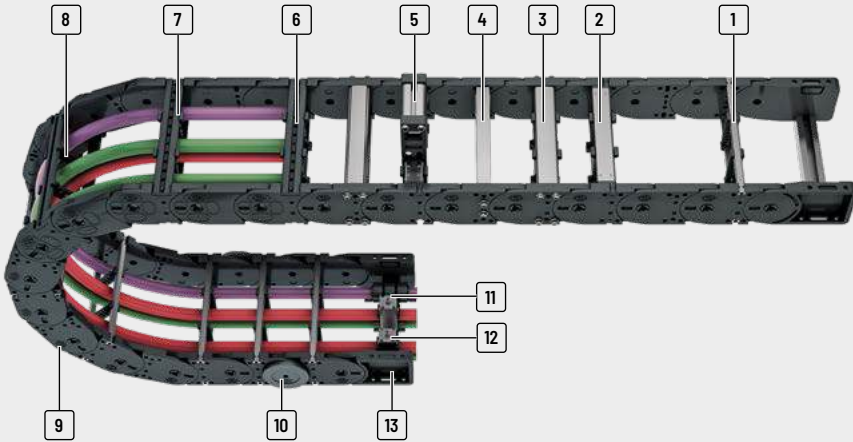

- | | | | |
|---|---|---|---|
| <p>1 Aluminum stays available in 1 mm width sections</p> <p>2 Aluminum stays in reinforced version</p> <p>3 Aluminum stays with 4 screw-fixing points for extreme loads</p> | <p>4 Aluminum hole stays</p> <p>5 Mounting frame stays</p> <p>6 Plastic stays available in 8 or 16 mm width sections</p> <p>7 Can be opened quickly on the inside and the outside for cable laying</p> | <p>8 Fixable dividers</p> <p>9 Molded slide runners</p> <p>10 Slide discs</p> <p>11 C-rail for strain relief elements</p> <p>12 Strain relief elements</p> | <p>13 Universal end connectors (UMB)</p> |
|---|---|---|---|

Features

- » Stable sidebands through robust link plate design
- » Encapsulated, dirt-resistant stroke system
- » Long service due to minimized hinge wear owing to the "life extending 2 disc principle"
- » Versions with aluminum stays available in 1 mm width sections up to 700 mm inner width
- » Versions with plastic stays available in 8 or 16 mm width sections
- » Large selection of vertical and horizontal stay separation options for your cables

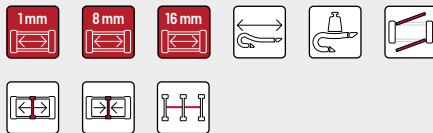

Minimized hinge wear owing to the "life extending 2 disc principle"















Slide discs for long service life for applications where the carrier is rotated through 90°



Molded slide runners for long service life in sliding arrangement



Many separation options for the cables

Type	Opening variant	Stay variant	h_i	h_G	B_i	B_k	B_i -grid	t	KR	Additional load \leq [kg/m]	Cable- d_{max} [mm]
			[mm]	[mm]	[mm]	[mm]	[mm]	[mm]	[mm]		
K0650											
		RS	38	57.5	75 - 400	103 - 428	1	65	75 - 300	20	30
		LG	36	57.5	75 - 600	103 - 628	1	65	75 - 300	20	32
		RMA	38 (200)	57.5 (224)	200 - 400	234 - 428	1	65	75 - 300	20	160
		RE	42	57.5	68 - 268	96 - 296	8	65	75 - 300	20	33
K0900											
		RS	58	78.5	100 - 400	131 - 431	1	90	130 - 385	30	46
		RV	58	78.5	100 - 500	131 - 531	1	90	130 - 385	30	46
		RM	54	78.5	100 - 600	131 - 631	1	90	130 - 385	30	43
		LG	50	78.5	100 - 700	131 - 731	1	90	130 - 385	30	42
		RMA	58 (200)	78.5 (224)	200 - 500	231 - 531	1	90	130 - 385	30	160
		RMR	51	78.5	100 - 600	131 - 631	1	90	130 - 385	30	41
	RE	58	78.5	81 - 561	112 - 592	16	90	130 - 385	30	46	

* Further information on request.

PROTUM®
seriesK
seriesUNIFLEX
Advanced
seriesM
seriesXL
seriesQUANTUM®
seriesTKR
seriesTKA
seriesUAT
series

Unsupported arrangement			Gliding arrangement			Inner Distribution				Movement			Page
Travel length ≤ [m]	v_{max} ≤ [m/s]	a_{max} ≤ [m/s ²]	Travel length ≤ [m]	v_{max} ≤ [m/s]	a_{max} ≤ [m/s ²]	TS0	TS1	TS2	TS3	vertical hanging or standing	lying on the side	rotating arrangement	
4.8	8	40	220	2	3	•	•	•	•	•	•	•	306
4.8	8	40	220	2	3	-	-	-	-	•	•	•	310
4.8	8	40	220	2	3	•	-	-	-	•	•	-	312
4.8	8	40	220	2	3	•	•	-	•	•	•	•	314
8.4	6	30	260	2	3	•	•	•	•	•	•	•	320
8.4	6	30	260	2	3	•	•	•	•	•	•	•	324
8.4	6	30	260	2	3	•	•	-	-	•	•	•	*
8.4	6	30	260	2	3	-	-	-	-	•	•	•	328
8.4	6	30	260	2	3	•	-	-	-	•	•	-	330
8.4	6	30	260	2	3	•	-	-	-	•	•	•	*
8.4	6	30	260	2	3	•	•	•	•	•	•	•	332

PROTUM® series

K series

UNIFLEX Advanced series

M series

XL series

QUANTUM® series

TKR series

TKA series

UAT series

K0650



Pitch
65 mm



Inner heights
36 - 42 mm



Inner widths
68 - 400 mm



Bending radii
75 - 300 mm

Stay variants



Aluminum stay RS page **306**

Frame stay, narrow "The standard"

- » Aluminum profile bars for light to medium loads. Assembly without screws.
- » **Outside/inside:** to open by rotating 90°.



Aluminum stay LG page **310**

Hole stay, split version

- » Optimum cable routing in the neutral bending line. Split version for easy cable routing. Stays also available unsplit.
- » **Outside/inside:** Screw-fixing easy to release.



Aluminum stay RMA page **312**

Mounting frame stay

- » Aluminum profile bars with plastic mounting frame stays for guiding very large cable diameters.
- » **Outside/inside:** Screw-fixing easy to release.



Plastic stay RE page **314**

Frame screw-in stay

- » Plastic profile bars for light to medium loads. Assembly without screws.
- » **Outside/inside:** to open by rotating 90°.

Unsupported arrangement

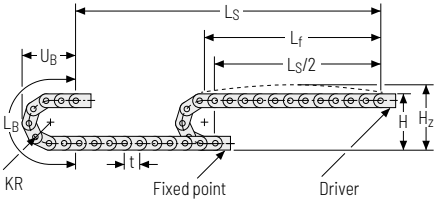

KR [mm]	H [mm]	H ₂ [mm]	L _B [mm]	U _B [mm]
75	205	245	366	168
115	285	325	492	208
145	345	385	586	238
175	405	445	680	268
220	495	535	822	313
300	655	695	1073	393

Load diagram for unsupported length depending on additional load.

Sagging of the cable carrier is technically permitted for extended travel lengths, depending on the specific application.

Intrinsic cable carrier weight $q_k = 2.5 \text{ kg/m}$. For other inner widths, the maximum additional load changes.

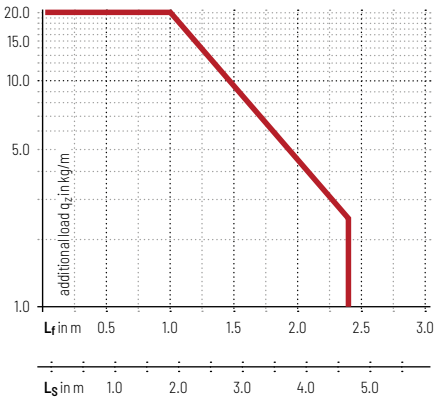

- Speed**
up to 8 m/s
- Acceleration**
up to 40 m/s²
- Travel length**
up to 4.8 m
- Additional load**
up to 20 kg/m

Gliding arrangement

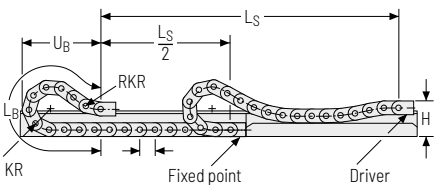

- Speed**
up to 2 m/s
- Acceleration**
up to 3 m/s²
- Travel length**
up to 220 m
- Additional load**
up to 20 kg/m

The gliding cable carrier must be guided in a channel. See p. 844.

If the cable carrier is positioned so it is rotated by 90° (gliding on the outside of the side band), slide discs snapped onto the side optimize the friction and wear situation.

PROTUM® series
K series
UNIFLEX Advanced series
M series
XL series
QUANTUM® series
TKR series
TKA series
UAT series

Aluminum stay RS – frame stay narrow

- » Extremely quick to open and close
- » Aluminum profile bars for light to medium loads. Assembly without screws.
- » Available customized in **1 mm width sections**.
- » **Outside/inside:** to open by rotating 90°.



Stay arrangement on every 2nd chain link, **standard** (HS: half-stayed)



Stay arrangement on each chain link (VS: fully-stayed)



1 mm B_i 75 – 400 mm in 1 mm width sections

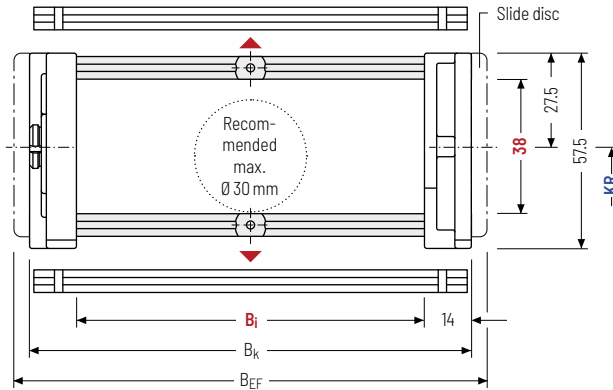

The maximum cable diameter strongly depends on the bending radius and the desired cable type. Please contact us.

Calculating the cable carrier length

Cable carrier length L_k

$$L_k \approx \frac{L_G}{2} + L_B$$

Cable carrier length L_k rounded to pitch t

h_i [mm]	h_G [mm]	B_i [mm]*	B_k [mm]	B_{EF} [mm]	KR [mm]					q_k [kg/m]	
38	575	75 - 400	$B_i + 28$	$B_i + 36$	75	115	145	175	220	300	1.87 - 3.60

* in 1 mm width sections

Order example



KC0650

Type

176

B_i [mm]

RS

Stay variant

115

KR [mm]

1430

L_k [mm]

HS

Stay arrangement

Divider systems

The divider system is mounted on each crossbar as a standard – on every 2nd chain link for stay mounting (HS – half-stayed).

For applications with lateral acceleration and rotated by 90°, the dividers can be attached by simply clipping on a socket (available as an accessory).

As a standard, dividers or the complete divider system (dividers with height separations) are movable in the cross section (**version A**).

This socket additionally acts as a spacer between the dividers and is available in a 1 mm grid between 3 – 50 mm. The inner height is reduced to 32 mm (**version B**).

Divider system TSO without height separation

Vers.	a _T min [mm]	a _x min [mm]	a _c min [mm]	n _T min
A	6,5	13	10	2

The dividers can be moved in the cross section.

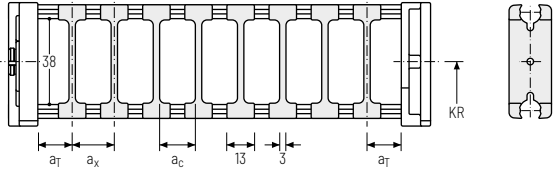

Divider system TS1 with continuous height separation

Vers.	a _T min [mm]	a _T max [mm]	a _x min [mm]	a _c min [mm]	n _T min
A	6,5	25	13	10	2

The dividers can be moved in the cross section.

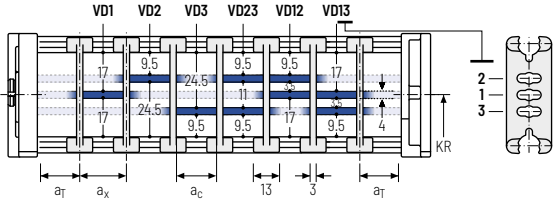

Divider system TS2 with partial height separation

Vers.	a _T min [mm]	a _x min [mm]	a _c min [mm]	n _T min
A	3,5	21	15	2

With grid distribution (1 mm grid). The dividers are attached by the height separation, the grid can be moved in the cross section.

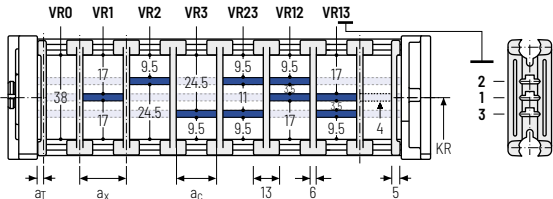

Sliding dividers are optionally available (thickness of divider = 3 mm).

PROTUM® series
K series
UNIFLEX Advanced series
M series
XL series
QUANTUM® series
TKR series
TKA series
UAT series

Additional product information online



Installation instructions, etc.: Additional info via your smartphone or check online at tsubaki-kabelschlepp.com/downloads



Configure your cable carrier here: online-engineer.de

Divider system TS3 with height separation consisting of plastic partitions

Vers.	a_T min [mm]	a_x min [mm]	a_c min [mm]	n_T min
A	4	16 / 42*	8	2

* For aluminum partitions

The dividers are fixed by the partitions, the complete divider system is movable in the cross section.

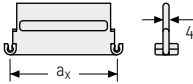
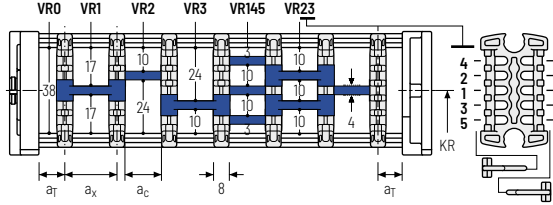

Aluminum partitions in 1 mm increments with $a_x > 42$ mm are also available.

a_x (center distance of dividers) [mm]											
a_c (nominal width of inner chamber) [mm]											
16	18	23	28	32	33	38	43	48	58	64	68
8	10	15	20	24	25	30	35	40	50	56	60
78	80	88	96	112	128	144	160	176	192	208	
70	72	80	88	104	120	136	152	168	184	200	

When using **plastic partitions with $a_x > 112$ mm**, we recommend an additional center support with a **twin divider** ($S_T = 4$ mm). Twin dividers are also suitable for retrofitting in the partition system.

Order example



TS3	.	A	.	3	.	K1	.	34	-	VR1
						⋮		⋮		⋮
						K4	.	38	-	VR3
Divider system		Version		n_T		Chamber		a_x		Height separation

Please state the designation of the divider system (**TS0, TS1,...**), the version, and the number of dividers per cross section [n_T]. In addition, please also enter the chambers [K] from left to right, as well as the assembly distances [a_T/a_x].

If using divider systems with height separation (**TS1 – TS3**), please also state the positions (e.g. VD23) viewed from the left driver belt. You are welcome to add a sketch to your order.



TOTALTRAX® complete systems

Benefit from the advantages of the TOTALTRAX® complete system. A complete delivery from one source – with a warranty certificate on request! Learn more at tsubaki-kabelschlepp.com/totaltrax

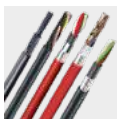

TRAXLINE® cables for cable carriers

Hi-flex electric cables which were especially developed, optimized and tested for use in cable carriers can be found at tsubaki-kabelschlepp.com/traxline

PROTUM®
series**K**
seriesUNIFLEX
Advanced
seriesM
seriesXL
seriesQUANTUM®
seriesTKR
seriesTKA
seriesUAT
series

Aluminum stay LG - Hole stay, split version

- » Optimum cable routing in the neutral bending line.
Split version for easy cable routing. Stays also available unsplit.
- » Available customized in **1 mm width sections**.
- » **Outside/inside:** Screw-fixing easy to release.



Stay arrangement on every 2nd chain link, **standard (HS: half-stayed)**



Stay arrangement on each chain link (**VS: fully-stayed**)



1 mm B_i 75 - 600 mm
in **1 mm width sections**

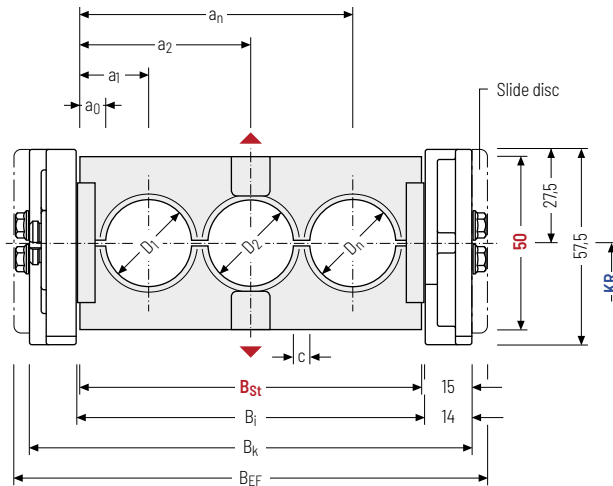

The maximum cable diameter strongly depends on the bending radius and the desired cable type. Please contact us.

Calculating the cable carrier length

Cable carrier length L_k

$$L_k \approx \frac{L_S}{2} + L_B$$

Cable carrier length L_k rounded to pitch t

Calculating the stay width

Stay width B_{St}

$$B_{St} = \sum D + \sum c + 2 a_0$$

The outer width of the cable carrier corresponds to dimension B_{EF} for stay variant LG.

D_{max} [mm]	D_{min} [mm]	h_G [mm]	B_i [mm]	B_{St} [mm]*	B_k [mm]	B_{EF} [mm]	c_{min} [mm]	a_0 min [mm]	KR [mm]	q_k 50%** [kg/m]	
36	9	57.5	75 - 600	73 - 598	$B_{St} + 30$	$B_{St} + 38$	4	9	75 175	115 220 145 300	2.20 - 5.15

* in 1 mm width sections ** Hole ratio of the hole stay approx. 50 %

Order example



KC0650

Type

176

B_i [mm]

LG

Stay variant

115

KR [mm]

1430

L_k [mm]

HS

Stay arrangement



Subject to change without notice.

PROTUM®
series

K
series

UNIFLEX
Advanced
series

M
series

XL
series

QUANTUM®
series

TKR
series

TKA
series

UAT
series

Aluminum stay RMA – mounting frame stay

- ▶ Aluminum profile bars with plastic mounting frame stays for guiding very large cable diameters.
- ▶ The mounting frame stay can be mounted either inside or outside in the bending radius. Available customized in 1 mm width sections.
- ▶ **Outside/inside:** Screw-fixing easy to release.



Stay arrangement on every 2nd chain link, **standard (HS: half-stayed)**



Stay arrangement on each chain link (**VS: fully-stayed**)



1mm B_i 200 – 400 mm in 1 mm width sections

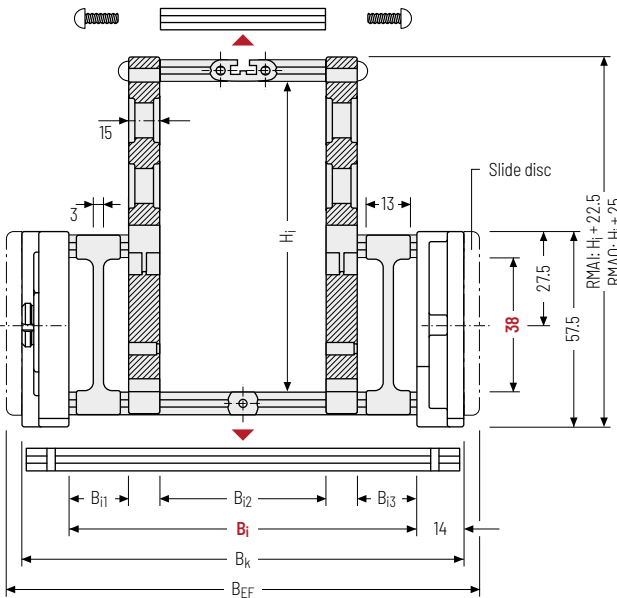

i The maximum cable diameter strongly depends on the bending radius and the desired cable type. Please contact us.

Calculating the cable carrier length

Cable carrier length L_k

$$L_k \approx \frac{L_S}{2} + L_B$$

Cable carrier length L_k rounded to pitch t

i Intrinsic cable carrier weight

Determining the intrinsic cable carrier weight strongly depends on the selected stay arrangement. Please contact us.

h_i [mm]	H_i [mm]	h_G [mm]	B_i [mm]	$B_{i1 \text{ min}}$ [mm]	$B_{i3 \text{ min}}$ [mm]	B_k [mm]	B_{EF} [mm]	KR [mm]
38	130 200	160	57.5	200 – 400	18	18	$B_i + 28$	$B_i + 36$
								75 175
								115 220
								145 300

Order example



KC0650

Type

276

B_i [mm]

RMAO

Stay variant

145

KR [mm]

1430

L_k [mm]

HS

Stay arrangement

Assembly variants

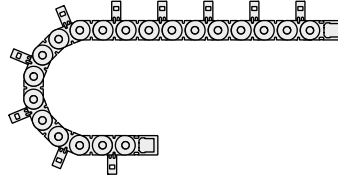
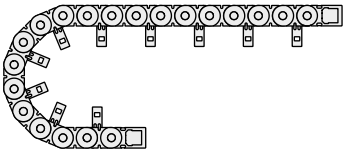

RMAI – assembly to the inside:

Gliding application is not possible when using assembly version RMAI.

Observe minimum KR:

$H_i = 130 \text{ mm}; KR_{\min} = 175 \text{ mm}$

$H_i = 160 \text{ mm}; KR_{\min} = 220 \text{ mm}$

$H_i = 200 \text{ mm}; KR_{\min} = 300 \text{ mm}$

RMAO – assembly to the outside:

The cable carrier has to rest on the side bands and not on the stays.

Guiding in a **channel is required** for support.

Please contact our technical support at technik@kabelschlepp.de to find the corresponding guide channel.

Please note the operating and installation height.



Subject to change without notice.

PROTUM® series
K series
UNIFLEX Advanced series
M series
XL series
QUANTUM® series
TKR series
TKA series
UAT series

Plastic stay RE -
screw-in frame stay

- » Plastic profile bars for light and medium loads.
Assembly without screws.
- » Available customized in **8 mm grid**.
- » **Outside/inside:** to open by rotating 90°.



Stay arrangement on every 2nd chain link, **standard** (HS: half-stayed)



Stay arrangement on each chain link (**VS: fully-stayed**)



8 mm B_i 68 - 260 mm in **8 mm width sections**

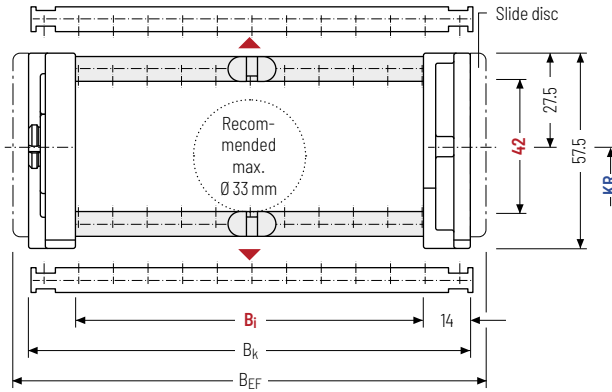

The maximum cable diameter strongly depends on the bending radius and the desired cable type. Please contact us.

Calculating the cable carrier length

Cable carrier length L_k

$$L_k \approx \frac{L_S}{2} + L_B$$

Cable carrier length L_k rounded to pitch t

h_i [mm]	h_g [mm]	B_i [mm]								B_k [mm]	B_{EF} [mm]	KR [mm]		q_k [kg/m]	
42	57.5	68	76	84	92	100	108	116	124	132	B _i + 28	B _i + 36	75	115	1.75
		140	148	156	164	172	180	188	196	204			145	175	-
		212	220	228	236	244	252	260	220	300			2.71		

Order example

KE0650 Type ·
 140 B_i [mm] ·
 RE Stay variant ·
 115 KR [mm] ·
 2600 L_k [mm] ·
 HS Stay arrangement

Divider systems

The divider system is mounted on each crossbar as a standard – on every 2nd chain link for stay mounting (HS – half-stayed).

As a standard, dividers or the complete divider system (dividers with height separations) are movable in the cross section (**version A**).

For applications with lateral accelerations and applications with the cable carrier rotated by 90°, the dividers can easily be fixed by turning the frame stay by 180°. The arresting cams click into place in the locking grids in the crossbar (**version B**). The groove in the frame stay faces outwards.

Divider system TSO without height separation

Vers.	a _T min [mm]	a _X min [mm]	a _C min [mm]	a _X grid [mm]	n _T min
A	6.5	13	8.8	-	2
B	13	16	11.8	8	2

The dividers can be moved in the cross section.

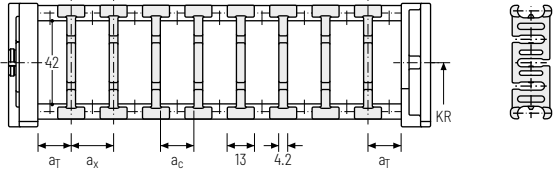

Divider system TS1 with continuous height separation

Vers.	a _T min [mm]	a _X min [mm]	a _C min [mm]	a _X grid [mm]	n _T min
A	6.5	13	8.8	-	2

The dividers can be moved in the cross section.

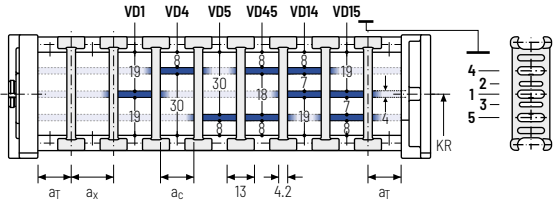

PROTUM® series
K series
UNIFLEX Advanced series
M series
XL series
QUANTUM® series
TKR series
TKA series
UAT series

Additional product information online



Installation instructions, etc.:
Additional info via your smartphone or check online at tsubaki-kabelschlepp.com/downloads



Configure your cable carrier here:
online-engineer.de

Divider system TS3 with height separation consisting of plastic partitions

Vers.	a_T min [mm]	a_x min [mm]	a_c min [mm]	n_T min
A	4	16 / 42*	8	2

* For aluminum partitions

The dividers are fixed with the partitions. The entire divider system can be moved in the cross section.

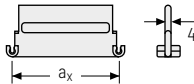
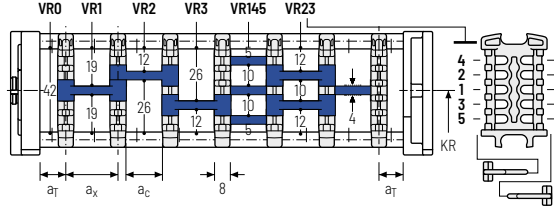

Aluminum partitions in 1 mm increments with $a_x > 42$ mm are also available.

a_x (center distance of dividers) [mm]											
a_c (nominal width of inner chamber) [mm]											
16	18	23	28	32	33	38	43	48	58	64	68
8	10	15	20	24	25	30	35	40	50	56	60
78	80	88	96	112	128	144	160	176	192	208	
70	72	80	88	104	120	136	152	168	184	200	

When using **plastic partitions with $a_x > 112$ mm**, we recommend an additional center support with a **twin divider** ($S_T = 4$ mm). Twin dividers are also suitable for retrofitting in the partition system.

Order example

TS3	.	A	.	3	.	K1	.	34	-	VR1
⋮		⋮		⋮		⋮		⋮		⋮
K4	.	38	-	VR3						
Divider system		Version		n_T		Chamber		a_x		Height separation

Please state the designation of the divider system (**TS0, TS1,...**), the version, and the number of dividers per cross section [n_T]. In addition, please also enter the chambers [K] from left to right, as well as the assembly distances [a_T/a_x].

If using divider systems with height separation (**TS1 – TS3**), please also state the positions (e.g. VD23) viewed from the left driver belt. You are welcome to add a sketch to your order.



TOTALTRAX® complete systems

Benefit from the advantages of the TOTALTRAX® complete system. A complete delivery from one source – with a warranty certificate on request! Learn more at tsubaki-kabelschlepp.com/totaltrax

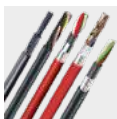

TRAXLINE® cables for cable carriers

Hi-flex electric cables which were especially developed, optimized and tested for use in cable carriers can be found at tsubaki-kabelschlepp.com/traxline

Universal end connectors UMB – plastic (standard)

The universal mounting brackets (UMB) are made from plastic and can be mounted **from the top, from the bottom or face on**.

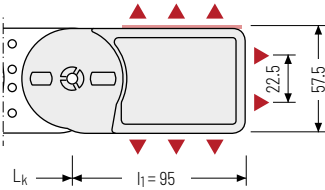

▲ Assembly options

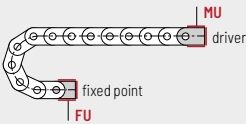
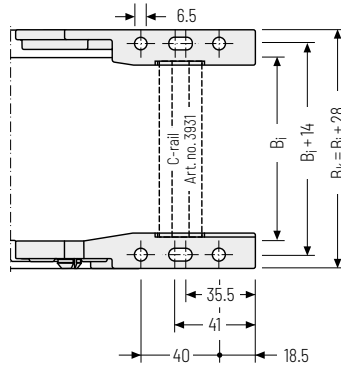

Connection point
F - fixed point
M - driver

Connection type
U - Universal mounting bracket

Order example

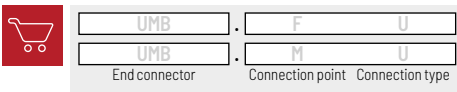

 We recommend the use of strain reliefs at the driver and fixed point. See from p. 904.

Additional product information online



Installation instructions, etc.:
 Additional info via your smartphone or check online at tsubaki-kabelschlepp.com/downloads



Configure your cable carrier here:
online-engineer.de

PROTUM® series
K series
UNIFLEX Advanced series
M series
XL series
QUANTUM® series
TKR series
TKA series
UAT series

K0900



Pitch
90 mm



Inner heights
50 – 58 mm



Inner widths
81 – 561 mm



Bending radii
130 – 385 mm

Stay variants



Aluminum stay RS page 320

Frame stay, narrow "The standard"

- » Aluminum profile bars for light to medium loads. Assembly without screws.
- » **Outside/inside:** to open by rotating 90°.



Aluminum stay RV page 324

Frame stay, reinforced

- » Aluminum profile bars plastic adapter for medium to high loads and large cable carrier widths. Assembly without screws.
- » **Outside/inside:** to open by rotating 90°.



Aluminum stay LG page 328

Hole stay, split version

- » Optimum cable routing in the neutral bending line. Split version for easy cable routing. Stays also available unsplit.
- » **Outside/inside:** Screw-fixing easy to release.



Aluminum stay RMA page 330

Mounting frame stay

- » Aluminum profile bars with plastic mounting frame stays for guiding very large cable diameters.
- » **Outside/inside:** Screw-fixing easy to release.



Plastic stay RE page 332

Frame screw-in stay

- » Plastic profile bars for light to medium loads. Assembly without screws.
- » **Outside/inside:** to open by rotating 90°.

Additional stay variants on request

Aluminum stay RM

Aluminum profile bars for high loads.

Aluminum stay RMR

Gentle cable guiding with rollers.

Unsupported arrangement

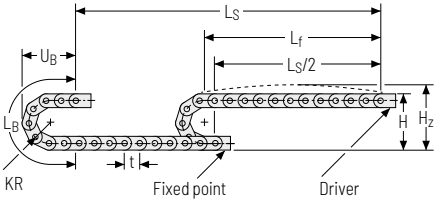





KR [mm]	H [mm]	H ₂ [mm]	L _B [mm]	U _B [mm]
130	336	386	589	258
150	376	426	652	278
190	456	506	777	318
245	566	616	950	373
300	676	726	1123	428
385	846	896	1390	513

Load diagram for unsupported length depending on the additional load.

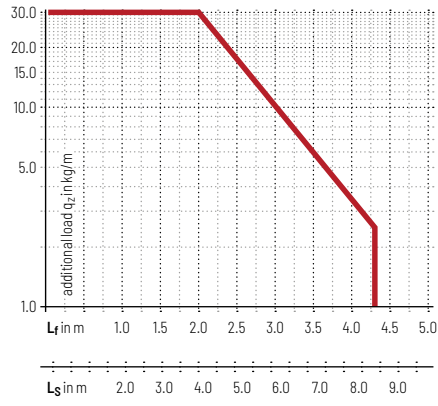
Sagging of the cable carrier is technically permitted for extended travel lengths, depending on the specific application.





Intrinsic cable carrier weight $q_k = 4.05 \text{ kg/m}$. For other inner widths, the maximum additional load changes.

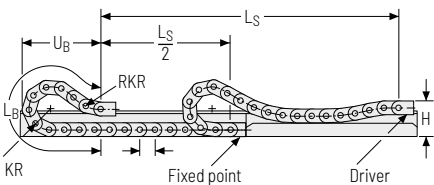

-  **Speed**
up to 6 m/s
-  **Acceleration**
up to 30 m/s^2
-  **Travel length**
up to 8.4 m
-  **Additional load**
up to 30 kg/m

Gliding arrangement



-  **Speed**
up to 2 m/s
-  **Acceleration**
up to 3 m/s^2
-  **Travel length**
up to 260 m
-  **Additional load**
up to 30 kg/m

 The gliding cable carrier must be guided in a channel. See p. 844.

If the cable carrier is positioned so it is rotated by 90° (gliding on the outside of the side band), slide discs snapped onto the side optimize the friction and wear situation.

PROTUM® series
K series
UNIFLEX Advanced series
M series
XL series
QUANTUM® series
TKR series
TKA series
UAT series

Aluminum stay RS - frame stay narrow

- » Extremely quick to open and close
- » Aluminum profile bars for light to medium loads.
Assembly without screws.
- » Available customized in **1 mm width sections**.
- » **Outside/inside:** to open by rotating 90°.



Stay arrangement on every
2nd chain link, **standard**
(**HS: half-stayed**)



Stay arrangement on each
chain link (**VS: fully-stayed**)



1 mm B_i 100 - 400 mm
in **1 mm width sections**

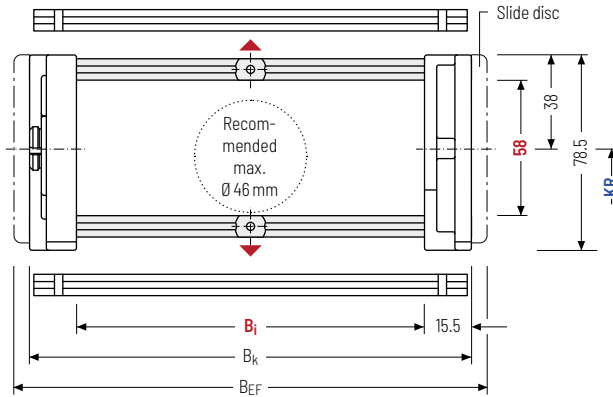

The maximum cable diameter strongly depends on the bending radius and the desired cable type. Please contact us.

Calculating the cable carrier length

Cable carrier length L_k

$$L_k \approx \frac{L_G}{2} + L_B$$

Cable carrier length L_k
rounded to pitch t

h_i [mm]	h_G [mm]	B_i [mm]*	B_k [mm]	B_{EF} [mm]	KR [mm]						q_k [kg/m]
58	78.5	100 - 400	$B_i + 31$	$B_i + 45$	130	150	190	245	300	385	2.8 - 5.8

* in 1 mm width sections

Order example



KC0900

Type

300

B_i [mm]

RS

Stay variant

150

KR [mm]

1890

L_k [mm]

HS

Stay arrangement

Divider systems

The divider system is mounted on each crossbar as a standard – on every 2nd chain link for stay mounting (HS – half-stayed).

As a standard, dividers or the complete divider system (dividers with height separations) are movable in the cross section (**version A**).

For applications with lateral acceleration and rotated by 90°, the dividers can be attached by simply clipping on a socket (available as an accessory).

The socket additionally serves as a spacer between the dividers and is available in 1 mm sections between 3 – 50 mm. The inner height is reduced to 54 mm (**version B**).

Divider system TSO without height separation

Vers.	a _T min [mm]	a _x min [mm]	a _c min [mm]	n _T min
A	7	14	10	2

The dividers can be moved in the cross section.

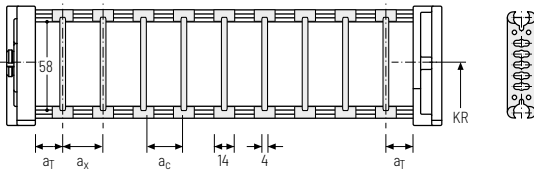

Divider system TS1 with continuous height separation

Vers.	a _T min [mm]	a _T max [mm]	a _x min [mm]	a _c min [mm]	n _T min
A	7	25	14	10	2

The dividers can be moved in the cross section.

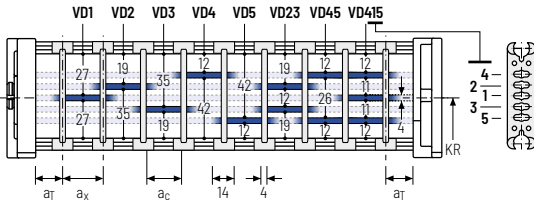



Divider system TS2 with partial height separation

Vers.	a _T min [mm]	a _x min [mm]	a _c min [mm]	n _T min
A	7	23	19	2

With grid distribution (1 mm grid). The dividers are attached by the height separation, the grid can be moved in the cross section.

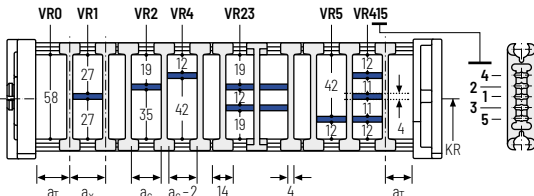
Sliding dividers are optionally available (thickness of divider = 4 mm).



 Please note that the real dimensions may deviate slightly from the values indicated here.

Order example

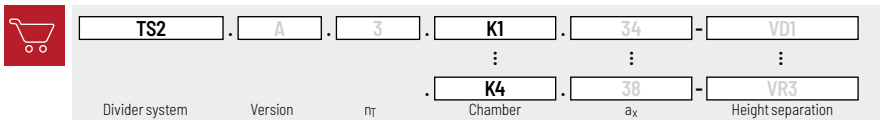

Divider system TS3 with height separation consisting of plastic partitions

As a standard, the divider **version A** is used for vertical partitioning within the cable carrier. The complete divider system can be moved within the cross section.

PROTUM® series

K series

Divider version A

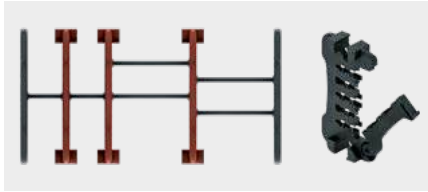

End divider

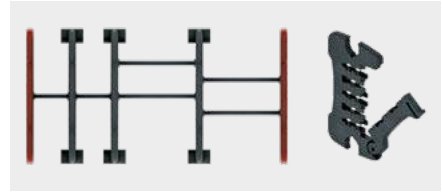

UNIFLEX Advanced series

M series

Vers.	a_T min [mm]	a_x min [mm]	a_c min [mm]	n_T min
A	6 / 2*	14	10	2

* For End divider

The dividers are fixed by the partitions, the complete divider system is movable in the cross section.

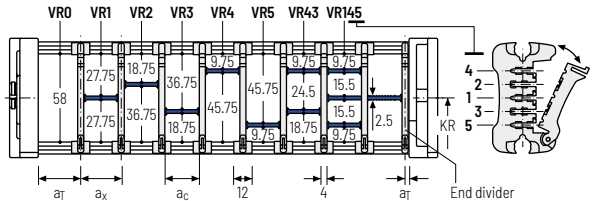

XL series

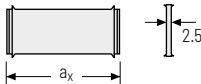

a_x (center distance of dividers) [mm]																
a_c (nominal width of inner chamber) [mm]																
14	16	19	23	24	28	29	32	33	34	38	39	43	44	48	49	54
10	12	15	19	20	24	25	28	29	30	34	35	39	40	44	45	50
58	59	64	68	69	74	78	79	80	84	88	89	94	96	99	112	
54	55	60	64	65	70	74	75	76	80	84	85	90	92	95	108	

When using **partitions with $a_x > 49$ mm** we recommended an additional preferential central support.

QUANTUM® series

Order example



TS3	A	3	K1	34	VR1
			:	:	:
			K4	38	VR3
Divider system	Version	n_T	Chamber	a_x	Height separation

TKR series

TKA series

Please state the designation of the divider system (**TS0, TS1,...**), version and number of dividers per cross section [n_T]. In addition, please also enter the chambers [K] from left to right, as well as the assembly distances [a_T/a_x] (as seen from the driver).

If using divider systems with height separation (**TS1, TS3**) please also state the positions [e.g. VD23] viewed from the left driver belt. You are welcome to add a sketch to your order.

UAT series

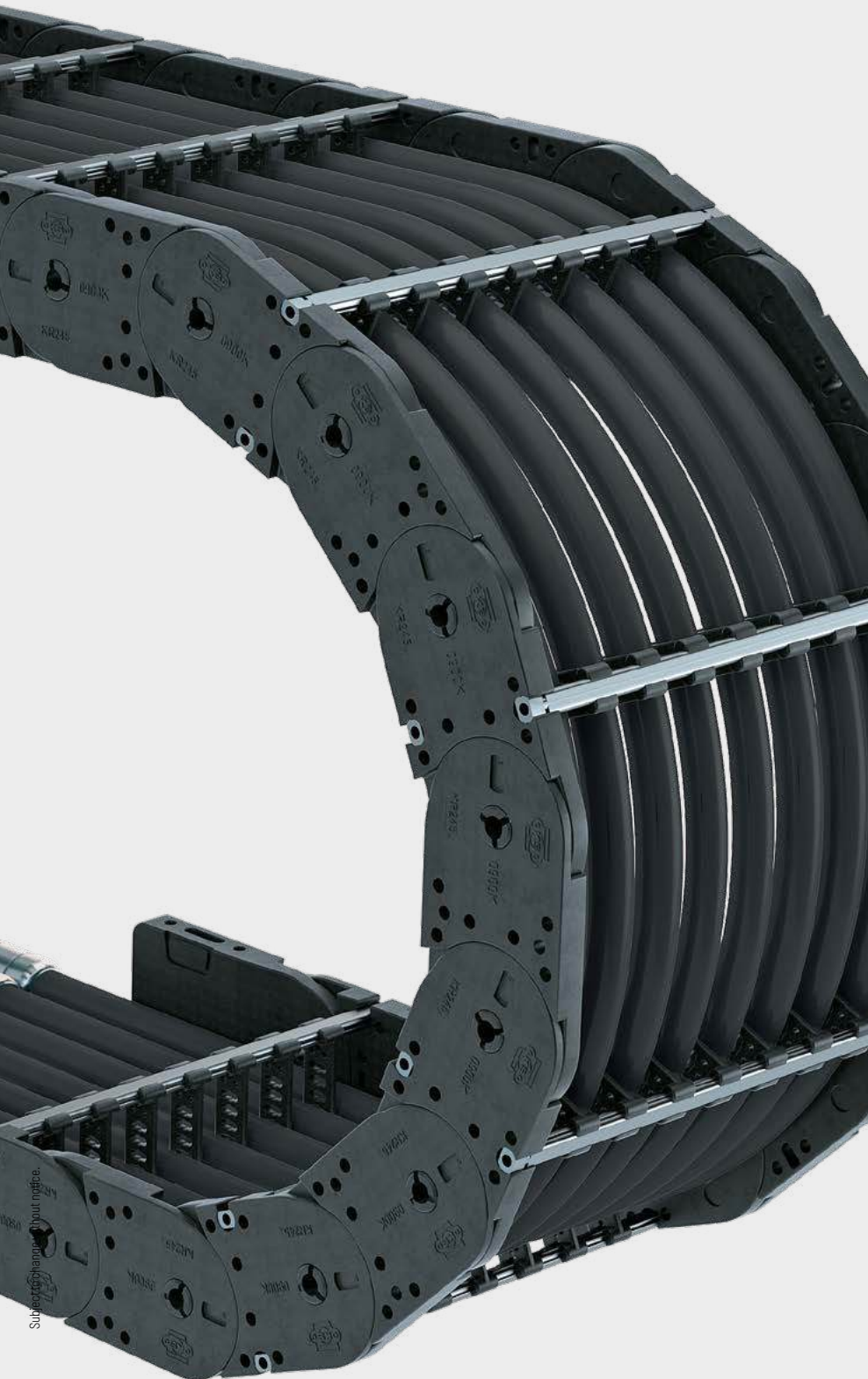

Subject to change without notice.

PROTUM®
series

K
series

UNIFLEX
Advanced
series

M
series

XL
series

QUANTUM®
series

TKR
series

TKA
series

UAT
series

Aluminum stay RV - frame stay reinforced

- » Aluminum profile bars plastic adapter for medium to high loads and large cable carrier widths. Assembly without screws.
- » Available customized in **1 mm grid**.
- » **Outside/inside:** to open by rotating 90°.



Stay arrangement on every 2nd chain link, **standard (HS: half-stayed)**



Stay arrangement on each chain link (**VS: fully-stayed**)



1 mm B_i 100 – 500 mm in **1 mm width sections**

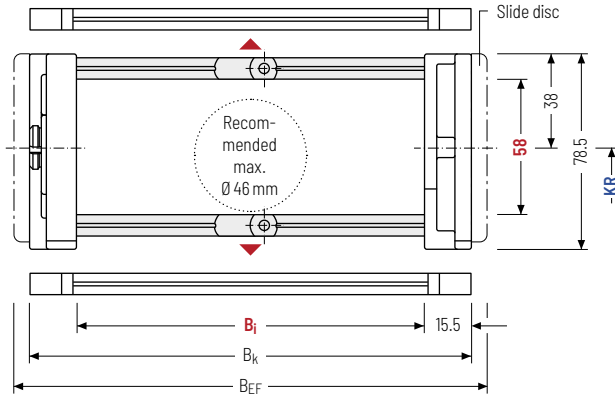

The maximum cable diameter strongly depends on the bending radius and the desired cable type. Please contact us.

Calculating the cable carrier length

Cable carrier length L_k

$$L_k \approx \frac{L_S}{2} + L_B$$

Cable carrier length L_k rounded to pitch t

h _i [mm]	h _G [mm]	B _i [mm]*	B _k [mm]	B _{EF} [mm]	KR [mm]			q _k [kg/m]			
58	78.5	100 – 500	B _i + 31	B _i + 45	130	150	190	245	300	385	3.2 – 7.0

* in 1 mm width sections

Order example



KC0900

Type

400

B_i [mm]

RV

Stay variant

150

KR [mm]

1890

L_k [mm]

HS

Stay arrangement

Divider systems

The divider system is mounted on each crossbar as a standard – on every 2nd chain link for stay mounting (HS – half-stayed).

As a standard, dividers or the complete divider system (dividers with height separations) are movable in the cross section (**version A**).

Divider system TSO without height separation

Vers.	a _T min [mm]	a _x min [mm]	a _c min [mm]	η _T min
A	7	14	10	-

The dividers can be moved in the cross section.

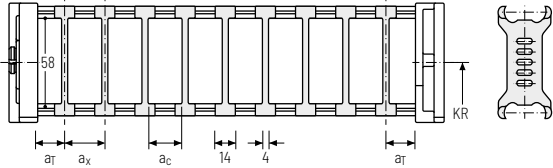

Divider system TS1 with continuous height separation

Vers.	a _T min [mm]	a _T max [mm]	a _x min [mm]	a _c min [mm]	η _T min
A	7	25	14	10	2

The dividers can be moved in the cross section.

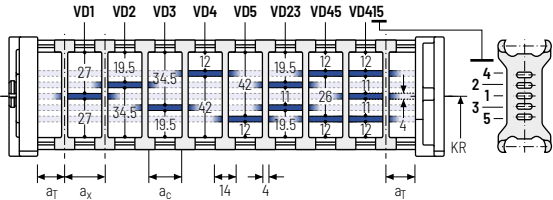

Divider system TS2 with partial height separation

Vers.	a _T min [mm]	a _x min [mm]	a _c min [mm]	η _T min
A	8	21	15	2

With grid distribution (1mm grid). The dividers are attached by the height separation, the grid can be moved in the cross section.

Sliding dividers are optionally available (thickness of divider = 4 mm).

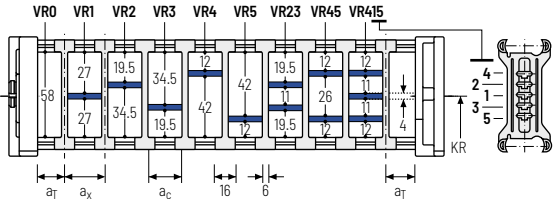

PROTUM® series
K series
UNIFLEX Advanced series
M series
XL series
QUANTUM® series
TKR series
TKA series
UAT series

Additional product information online



Installation instructions, etc.: Additional info via your smartphone or check online at tsubaki-kabelschlepp.com/downloads



Configure your cable carrier here: online-engineer.de

Divider system TS3 with height separation consisting of plastic partitions

Vers.	a_T min [mm]	a_x min [mm]	a_c min [mm]	n_T min
A	4	16 / 42*	8	2

* For aluminum partitions

The dividers are fixed by the partitions, the complete divider system is movable in the cross section.

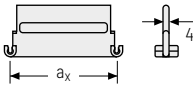
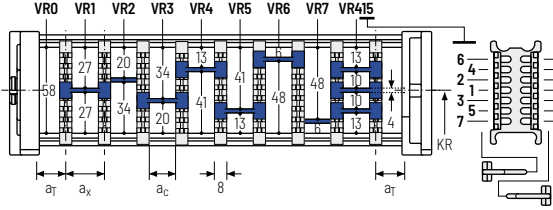

Aluminum partitions in 1 mm increments with $a_x > 42$ mm are also available.

a_x (center distance of dividers) [mm]											
a_c (nominal width of inner chamber) [mm]											
16	18	23	28	32	33	38	43	48	58	64	68
8	10	15	20	24	25	30	35	40	50	56	60
78	80	88	96	112	128	144	160	176	192	208	
70	72	80	88	104	120	136	152	168	184	200	

When using **plastic partitions with $a_x > 112$ mm**, we recommend an additional center support with a **twin divider** ($S_T = 4$ mm). Twin dividers are also suitable for retrofitting in the partition system.

Order example

TS3

A

3

K1

34

VR1

⋮
⋮
⋮

K4

38

VR3

Divider system
Version
 n_T
Chamber
 a_x
Height separation

Please state the designation of the divider system (**TS0, TS1,...**), the version, and the number of dividers per cross section [n_T]. In addition, please also enter the chambers [K] from left to right, as well as the assembly distances [a_T/a_x].

If using divider systems with height separation (**TS1 - TS3**), please also state the positions (e.g. VD23) viewed from the left driver belt. You are welcome to add a sketch to your order.

Additional product information online



Installation instructions, etc.:
 Additional info via your smartphone or check online at
[tsubaki-kabelschlepp.com/downloads](https://www.tsubaki-kabelschlepp.com/downloads)



Configure your cable carrier here:
[online-engineer.de](https://www.online-engineer.de)

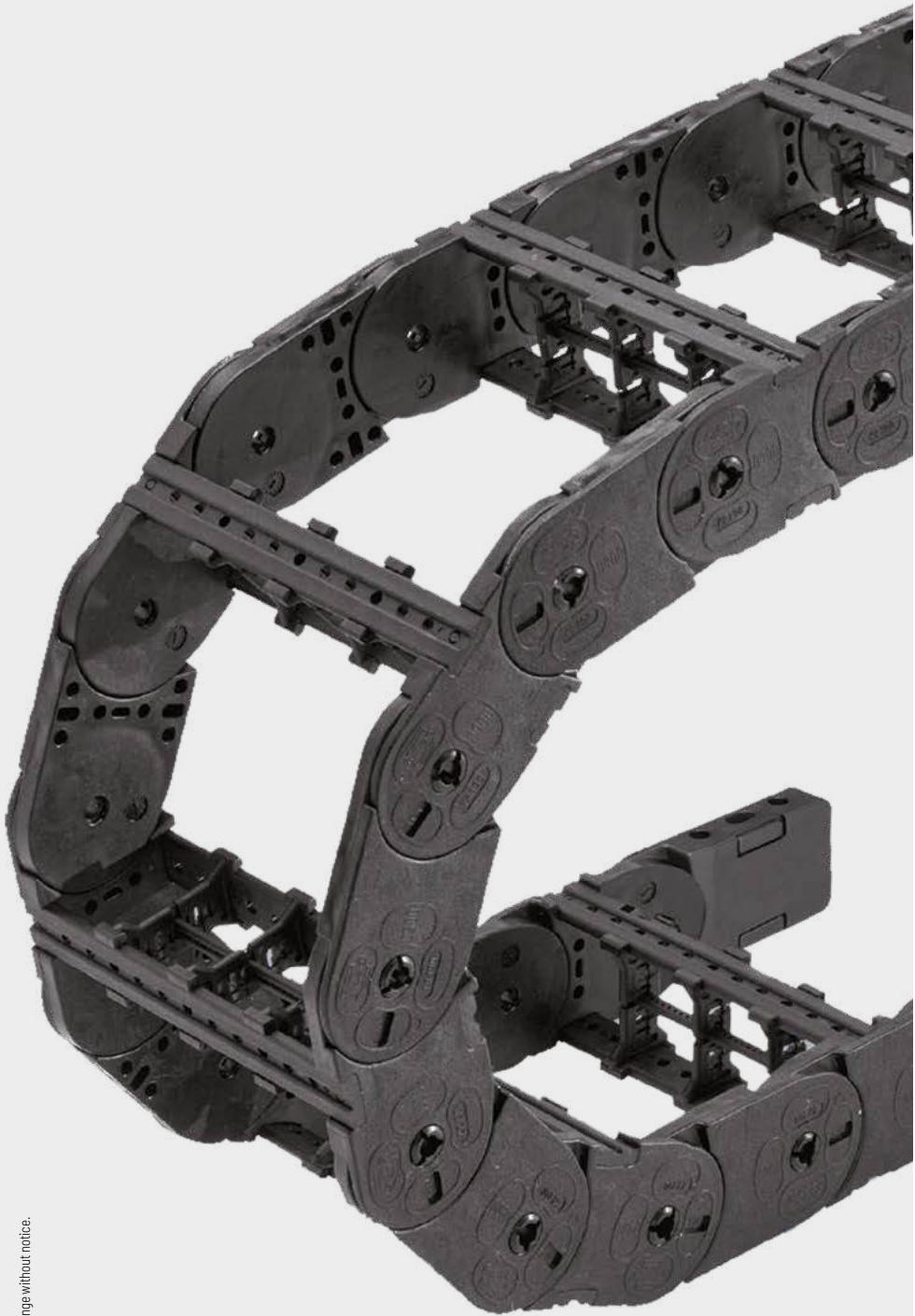

UAT
series

TKA
series

TKR
series

QUANTUM®
series

XL
series

M
series

UNIFLEX
Advanced
series

K
series

PROTUM®
series

Aluminum stay LG - Hole stay, split version

- » Optimum cable routing in the neutral bending line.
Split version for easy cable routing. Stays also available unsplit.
- » Available customized in **1 mm width sections**.
- » **Outside/inside:** Screw-fixing easy to release.



Stay arrangement on every 2nd chain link, **standard** (HS: half-stayed)



Stay arrangement on each chain link (VS: fully-stayed)



1mm B_i 100 – 700 mm
in 1 mm width sections

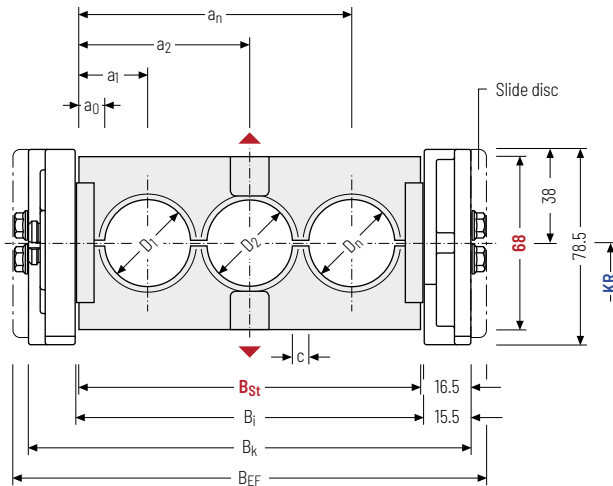

The maximum cable diameter strongly depends on the bending radius and the desired cable type. Please contact us.

Calculating the cable carrier length

Cable carrier length L_k

$$L_k \approx \frac{L_S}{2} + L_B$$

Cable carrier length L_k rounded to pitch t

Calculating the stay width

Stay width B_{St}

$$B_{St} = \sum D + \sum c + 2 a_0$$

The outer width of the cable carrier corresponds to dimension B_{EF} for stay variant LG.

D _{max} [mm]	D _{min} [mm]	h _G [mm]	B _i [mm]	B _{St} [mm]*	B _k [mm]	B _{EF} [mm]	c _{min} [mm]	a ₀ min [mm]	KR [mm]	q _k 50%** [kg/m]		
50	10	78.5	100 – 700	98 – 698	B _{St} + 33	B _{St} + 45	4	11	130 245	150 300	190 385	4.79 – 9.83

* in 1 mm width sections ** Hole ratio of the hole stay approx. 50 %

Order example



KC0900

Type

400

B_i [mm]

LG

Stay variant

150

KR [mm]

1890

L_k [mm]

HS

Stay arrangement



PROTUM®
series

K
series

UNIFLEX
Advanced
series

M
series

XL
series

QUANTUM®
series

TKR
series

TKA
series

UAT
series

Aluminum stay RMA – mounting frame stay

- ▶ Aluminum profile bars with plastic mounting frame stays for guiding very large cable diameters.
- ▶ The mounting frame stay can be mounted either inside or outside in the bending radius. Available customized in **1 mm width sections**.
- ▶ **Outside/inside:** Screw-fixing easy to release.

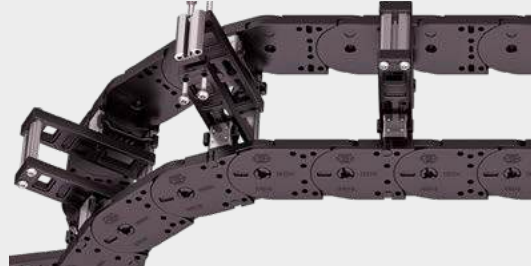

Stay arrangement on every 2nd chain link, **standard (HS: half-stayed)**



Stay arrangement on each chain link (**VS: fully-stayed**)



1 mm B_i 200 – 500 mm in **1 mm width sections**

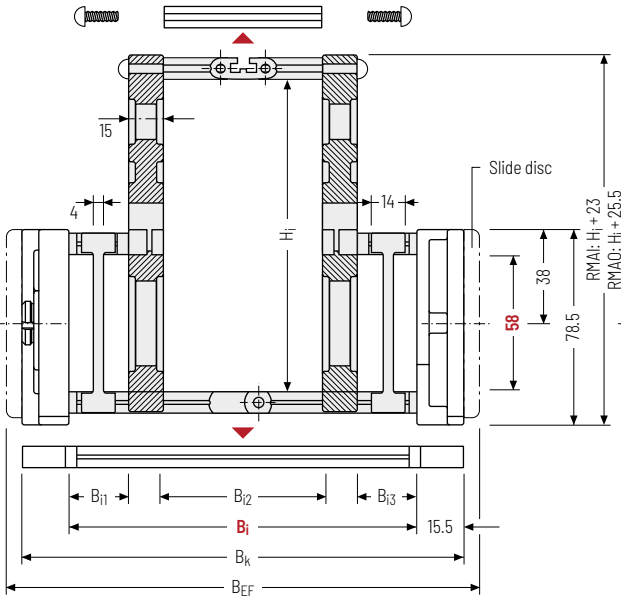

i The maximum cable diameter strongly depends on the bending radius and the desired cable type. Please contact us.

Calculating the cable carrier length

Cable carrier length L_k

$$L_k \approx \frac{L_S}{2} + L_B$$

Cable carrier length L_k rounded to pitch t

i Intrinsic cable carrier weight

Determining the intrinsic cable carrier weight strongly depends on the selected stay arrangement. Please contact us.

h_i [mm]	H_i [mm]	h_G [mm]	B_i [mm]	$B_{i1 \text{ min}}$ [mm]	$B_{i3 \text{ min}}$ [mm]	B_k [mm]	B_{EF} [mm]	KR [mm]
58	130 200	160	78.5	200 - 500	40	40	$B_i + 31$ $B_i + 45$	130 245
								150 300
								190 385

Order example



KC0900

Type

400

B_i [mm]

RMAO

Stay variant

150

KR [mm]

1890

L_k [mm]

HS

Stay arrangement

Assembly variants

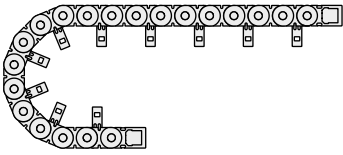

RMAI – assembly to the inside:

Gliding application is not possible when using assembly version RMAI.

Observe minimum KR:

H_i = 130 mm: KR_{min} = 150 mm

H_i = 160 mm: KR_{min} = 190 mm

H_i = 200 mm: KR_{min} = 245 mm

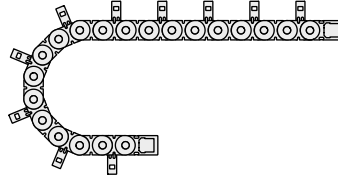

RMAO – assembly to the outside:

The cable carrier has to rest on the side bands and not on the stays.

Guiding in a **channel is required** for support.

Please contact our technical support at technik@kabelschlepp.de to find the corresponding guiding channel.

Please note the operating and installation height.

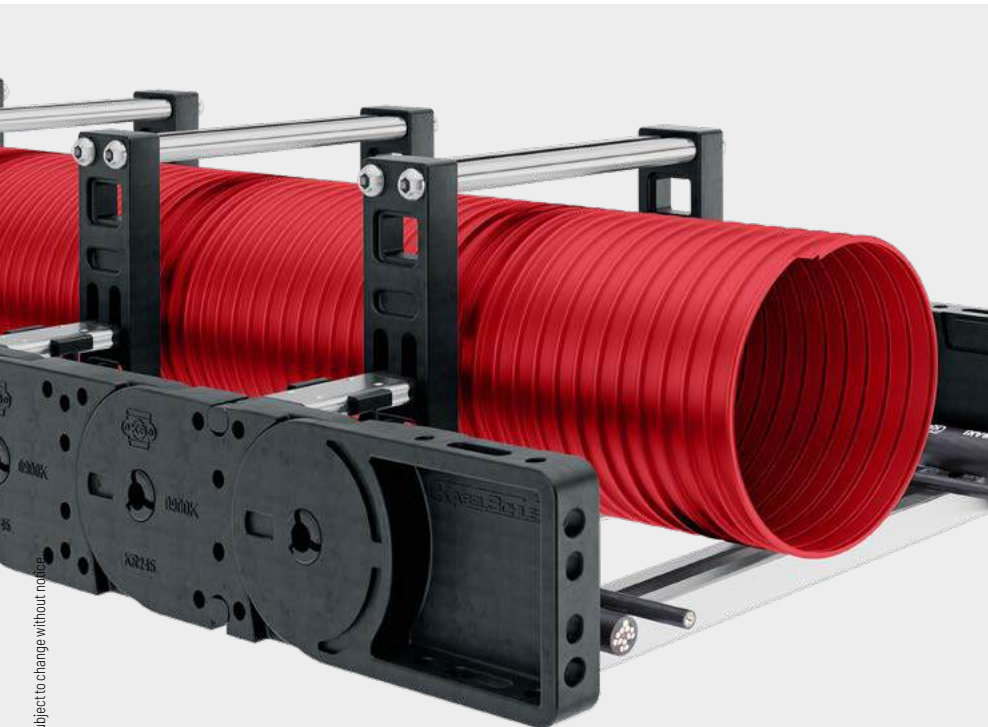

Subject to change without notice

PROTUM® series
K series
UNIFLEX Advanced series
M series
XL series
QUANTUM® series
TKR series
TKA series
UAT series

Plastic stay RE - frame screw-in stay

- » Plastic profile bars for light to medium loads.
Assembly without screws.
- » Available customized in **16 mm grid**.
- » **Outside/inside:** to open by rotating 90°.



Stay arrangement on every 2nd chain link, **standard** (HS: half-stayed)



Stay arrangement on each chain link (VS: fully-stayed)



16 mm B_i 81 – 561 mm
in **16 mm width sections**

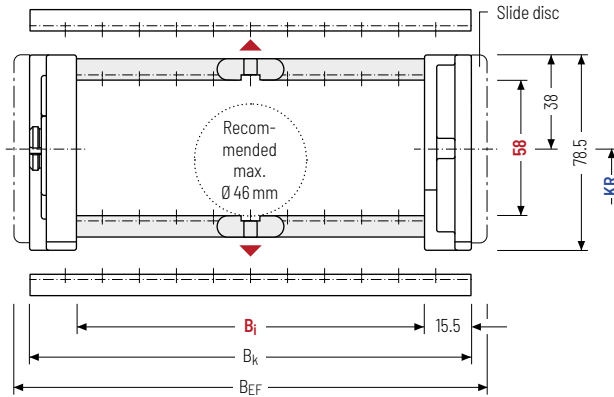

The maximum cable diameter strongly depends on the bending radius and the desired cable type. Please contact us.

Calculating the cable carrier length

Cable carrier length L_k

$$L_k \approx \frac{L_S}{2} + L_B$$

Cable carrier length L_k
rounded to pitch t

h ₁ [mm]	h _G [mm]	B _i [mm]										B _k [mm]	B _{EF} [mm]	KR [mm]		q _k [kg/m]
58	78.5	81	97	113	129	145	161	177	193	209	225	B _i + 31	B _i + 45	130	150	2.95
		241	257	273	289	305	321	337	353	369	385			190	245	-
		401	417	433	449	465	481	497	513	545	561			300	385	5.95

Order example



KE0900

Type

209

B_i [mm]

RE

Stay variant

150

KR [mm]

1890

L_k [mm]

HS

Stay arrangement

Divider systems

The divider system is mounted on each crossbar as a standard – on every 2nd chain link for stay mounting (HS – half-stayed).

For applications with lateral accelerations and applications with the cable carrier rotated by 90°, the dividers can easily be fixed by turning the frame stay by 180°. The arresting cams click into place in the locking grids in the crossbar (**version B**).

As a standard, dividers or the complete divider system (dividers with height separations) are movable in the cross section (**version A**).

The groove in the frame stay faces outwards.

Divider system TSO without height separation

Vers.	a _T min [mm]	a _x min [mm]	a _c min [mm]	a _x Raster [mm]	Π _T min
A	7,5	14,5	8,5	-	-
B	8,5	16	10	16	-

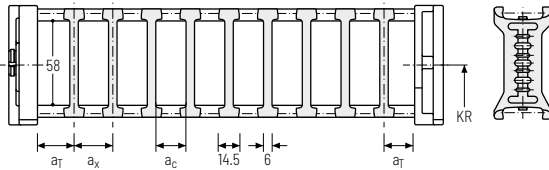

The dividers can be moved within the cross section (version A) or fixed (version B).

Divider system TS1 with continuous height separation

Vers.	a _T min [mm]	a _x min [mm]	a _c min [mm]	a _x Raster [mm]	Π _T min
A	7,5	14,5	8,5	-	2
B	8,5	16	10	16	2

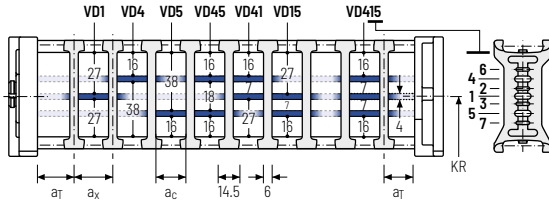

The dividers can be moved within the cross section (version A) or fixed (version B).

Divider system TS2 with partial height separation

Vers.	a _T min [mm]	a _x min [mm]	a _c min [mm]	a _x Raster [mm]	Π _T min
A	7,5	14,5*/21	8,5*/15	-	2
B	8,5	16*/32	10*/26	16	2

* for VR0

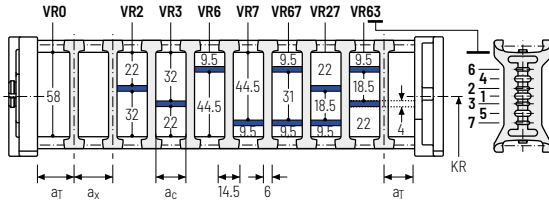

With grid distribution (16 mm grid). The dividers are attached by the height separation, the grid can be moved in the cross section (version A) or fixed (version B).

PROTUM® series

K series

UNIFLEX Advanced series

M series

XL series

QUANTUM® series

TKR series

TKA series

UAT series

Additional product information online



Installation instructions, etc.: Additional info via your smartphone or check online at tsubaki-kabelschlepp.com/downloads



Configure your cable carrier here: online-engineer.de

Divider system TS3 with height separation consisting of plastic partitions

Vers.	a_T min [mm]	a_x min [mm]	a_c min [mm]	n_T min
A	4	16 / 42*	8	2

* For aluminum partitions

The dividers are fixed by the partitions, the complete divider system is movable in the cross section.

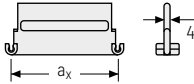
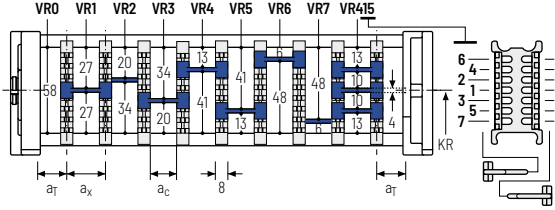

Aluminum partitions in 1 mm increments with $a_x > 42$ mm are also available.

a_x (center distance of dividers) [mm]											
a_c (nominal width of inner chamber) [mm]											
16	18	23	28	32	33	38	43	48	58	64	68
8	10	15	20	24	25	30	35	40	50	56	60
78	80	88	96	112	128	144	160	176	192	208	
70	72	80	88	104	120	136	152	168	184	200	

When using **plastic partitions with $a_x > 112$ mm**, we recommend an additional center support with a **twin divider** ($S_T = 4$ mm). Twin dividers are also suitable for retrofitting in the partition system.

Order example



TS3	.	A	.	3	.	K1	.	34	-	VR1
						⋮		⋮		⋮
						K4	.	38	-	VR3
Divider system		Version		n_T		Chamber		a_x		Height separation

Please state the designation of the divider system (**TS0, TS1,...**), the version, and the number of dividers per cross section [n_T]. In addition, please also enter the chambers [K] from left to right, as well as the assembly distances [a_T/a_x].

If using divider systems with height separation (**TS1 – TS3**), please also state the positions (e.g. VD23) viewed from the left driver belt. You are welcome to add a sketch to your order.



TOTALTRAX® complete systems

Benefit from the advantages of the TOTALTRAX® complete system. A complete delivery from one source – with a warranty certificate on request! Learn more at tsubaki-kabelschlepp.com/totaltrax

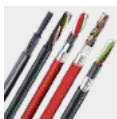

TRAXLINE® cables for cable carriers

Hi-flex electric cables which were especially developed, optimized and tested for use in cable carriers can be found at tsubaki-kabelschlepp.com/traxline

Universal end connectors UMB – plastic (standard)

The universal mounting brackets (UMB) are made from plastic and can be mounted **from the top, from the bottom, face on or from the side.**

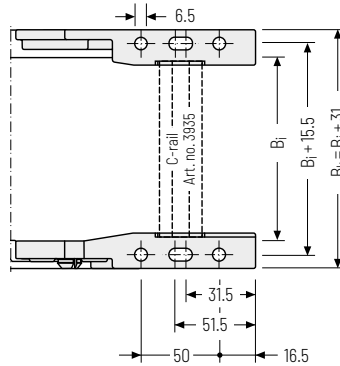
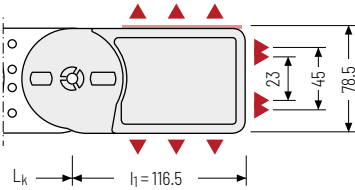

▲ Assembly options

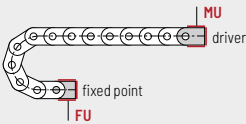

Connection point
F - fixed point
M - driver

Connection type
U - Universal mounting bracket

Order example

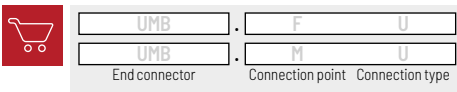

 We recommend the use of strain reliefs at the driver and fixed point. See from p. 904.

Additional product information online



Installation instructions, etc.:
 Additional info via your smartphone or check online at tsubaki-kabelschlepp.com/downloads



Configure your cable carrier here:
online-engineer.de

PROTUM® series
K series
UNIFLEX Advanced series
M series
XL series
QUANTUM® series
TKR series
TKA series
UAT series